



40V/80A N-Channel Advanced Power MOSFET

Features

- Improved dv/dt Capability, High Ruggedness.
- Maximum Junction Temperature Range (150°C)

BVDSS	40	V
ID	80	A
RDSON@VGS=10V	4.8	mΩ
RDSON@VGS=4.5V	6.6	mΩ

Applications

- High Side Load Switch
- Battery Switch
- Optimized for Power Management Applications for Portable Products, such as Aeromodelling, Power bank, Brushless motor, Main board , and Others

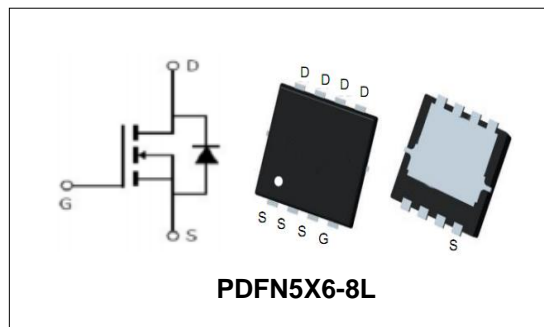

Order Information

Product	Package	Marking	Reel Size	Reel	Carton
PTN4080	PDFN5X6-8L	PTN4080	13inch	5000PCS	50000PCS

Absolute Maximum Ratings

Symbol	Parameter	Rating	Unit	
Common Ratings (TC=25°C Unless Otherwise Noted)				
$V_{(BR)DSS}$	Drain-Source Breakdown Voltage	40	V	
V_{GS}	Gate-Source Voltage	±20	V	
T_J	Maximum Junction Temperature	150	°C	
T_{STG}	Storage Temperature Range	-55 to 150	°C	
I_S	Diode Continuous Forward Current	TC =25°C	80	A
Mounted on Large Heat Sink				
E_{AS}	Single Pulse Avalanche Energy (Note1)	127	mJ	
I_{DM}	Pulse Drain Current Tested (Silicon Limit) (Note2)	TC =25°C	320	A
I_D	Continuous Drain current	TC =25°C	80	A
P_D	Maximum Power Dissipation	TC =25°C	41	W
$R_{\theta Jc}$	Thermal Resistance Junction-to-Case (Note3)	3	°C/W	



40V/80A N-Channel Advanced Power MOSFET

Symbol	Parameter	Condition	Min.	Typ.	Max.	Unit
Static Electrical Characteristics @ T_J = 25°C (unless otherwise stated)						
V _{(BR)DSS}	Drain- Source Breakdown Voltage	VGS=0V ID=250μA	40	--	--	V
I _{DSS}	Zero Gate Voltage Drain current	VDS=40V,VGS=0V	--	--	1	μA
I _{GSS}	Gate-Body Leakage Current	VGS=±20V,VDS=0V	--	--	±100	nA
V _{GS(TH)}	Gate Threshold Voltage	VDS=VGS,ID=250μA	1	1.6	2.5	V
R _{DS(ON)}	Drain-Source On-State Resistance (Note4)	VGS=10V, ID=20A	--	4.8	6.5	mΩ
		VGS=4.5V, ID=10A	--	6.6	8	mΩ
Dynamic Electrical Characteristics @ T_J = 25°C (unless otherwise stated) (Note5)						
C _{iss}	Input Capacitance	VDS=20V, VGS=0V, F=1MHz	--	2610	--	pF
C _{oss}	Output Capacitance		--	204	--	pF
C _{rss}	Reverse Transfer Capacitance		--	19	--	pF
Q _g	Total Gate Charge	VDS=20V, ID=20A, VGS=10V	--	37	--	nC
Q _{gs}	Gate-Source Charge		--	7	--	nC
Q _{gd}	Gate-Drain Charge		--	18	--	nC
Switching Characteristics (Note5)						
t _{d(on)}	Turn-on Delay Time	VDD=20V, ID=10A, VGS=10V, RG=4.7Ω	--	16	--	nS
t _r	Turn-on Rise Time		--	15	--	nS
t _{d(off)}	Turn-off Delay Time		--	20	--	nS
t _f	Turn-off Fall Time		--	12	--	nS
Source- Drain Diode Characteristics @ T_J = 25°C (unless otherwise stated)						
V _{SD}	Forward on voltage	IS=20A,VGS=0V	--	--	1.2	V

Note:

- Limited by T_{Jmax}, starting T_J = 25° C, R_G = 25Ω, V_D =20V, V_G =10V. Part not recommended for use above this value.
- Repetitive Rating: Pulse width limited by maximum junction temperature.
- Surface Mounted on FR4 Board, t ≤ 10 sec.
- Pulse Test: pulse width ≤ 300 us, duty cycle ≤ 2%.
- Guaranteed by design, not subject to production testing.



40V/80A N-Channel Advanced Power MOSFET

Typical Characteristics

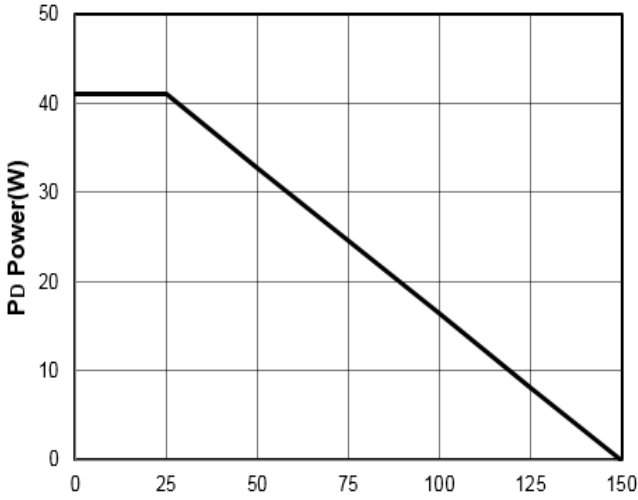

Figure1: T_J Junction Temperature ($^{\circ}C$)

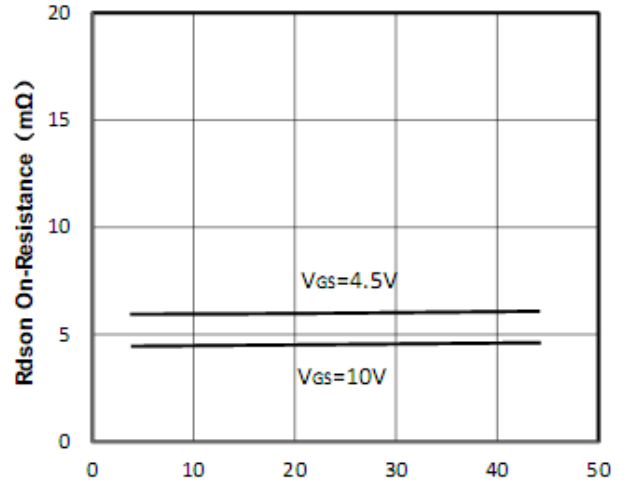

Figure2: I_D Drain Current (A)

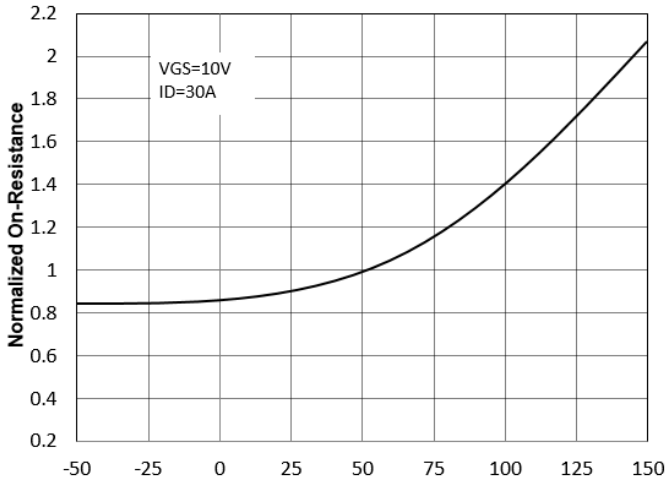

Figure3: T_J Junction Temperature ($^{\circ}C$)

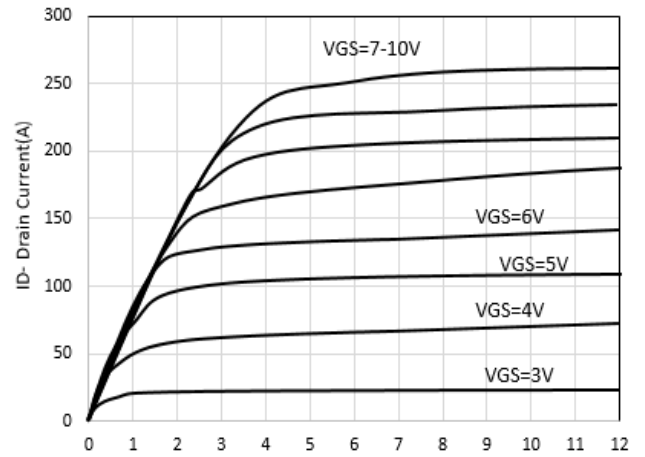

Figure4: V_{DS} Drain-Source Voltage (V)

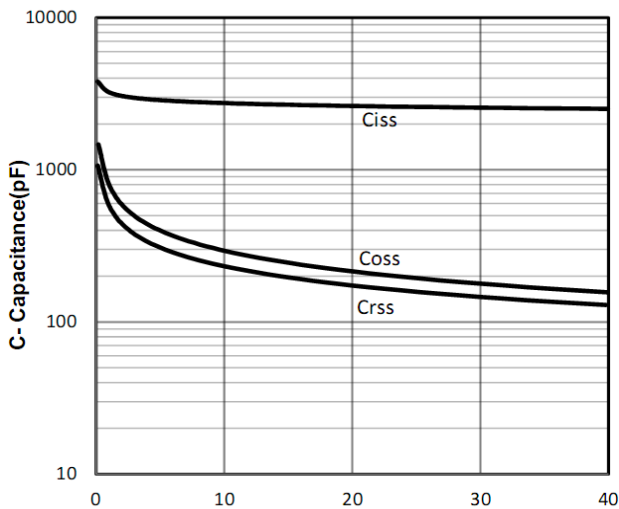

Figure5: V_{DS} Drain-Source Voltage (V)

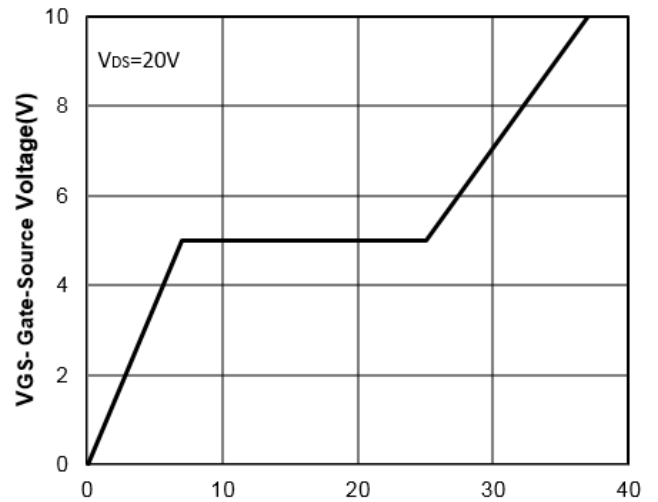

Figure6: Q_g Gate Charge (nC)



40V/80A N-Channel Advanced Power MOSFET

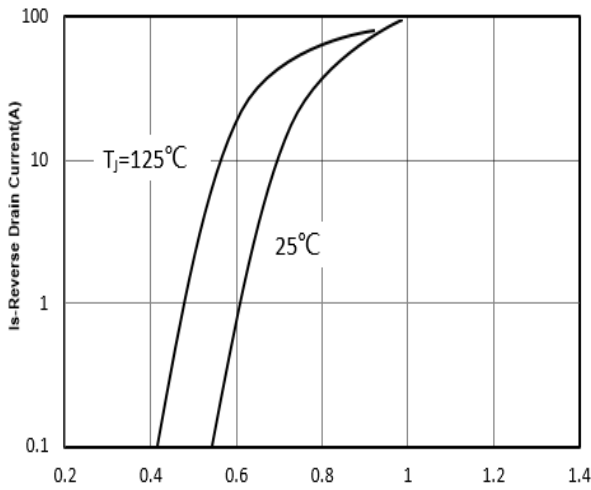

Figure7: Vsd Source-Drain Voltage (V)

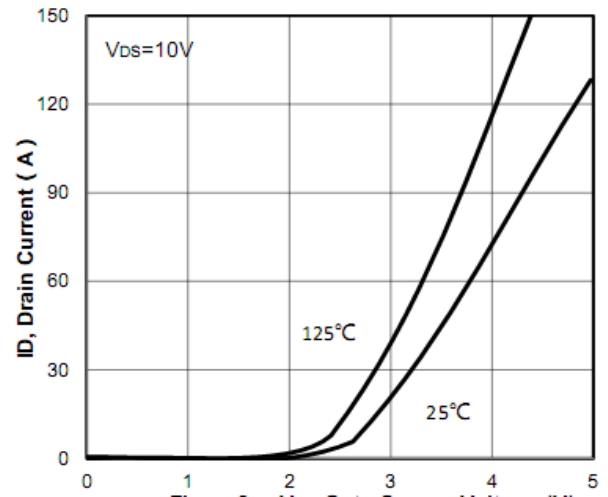

Figure8: Vgs Gate-Source Voltage (V)

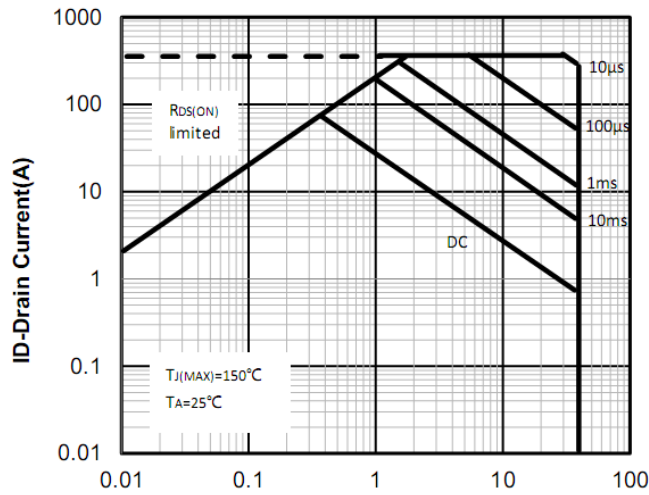

Figure9: Vds Drain -Source Voltage (V)

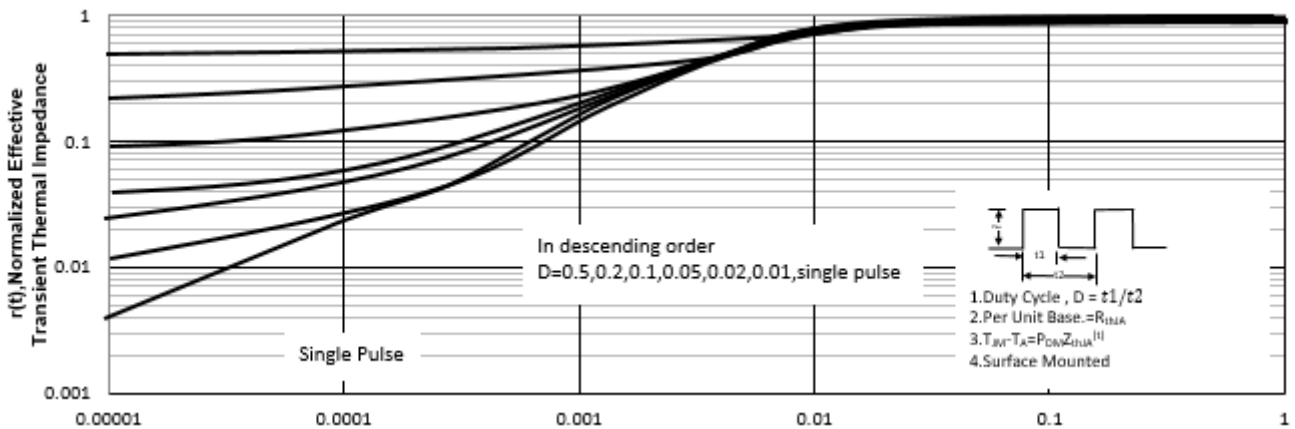
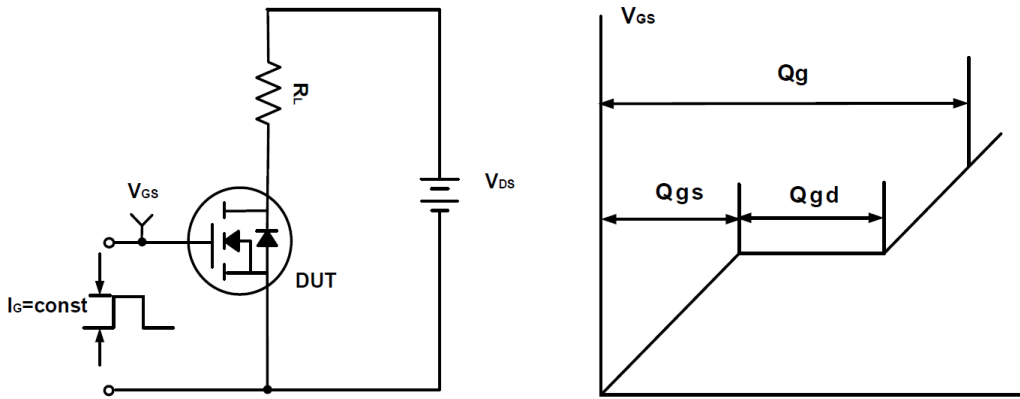
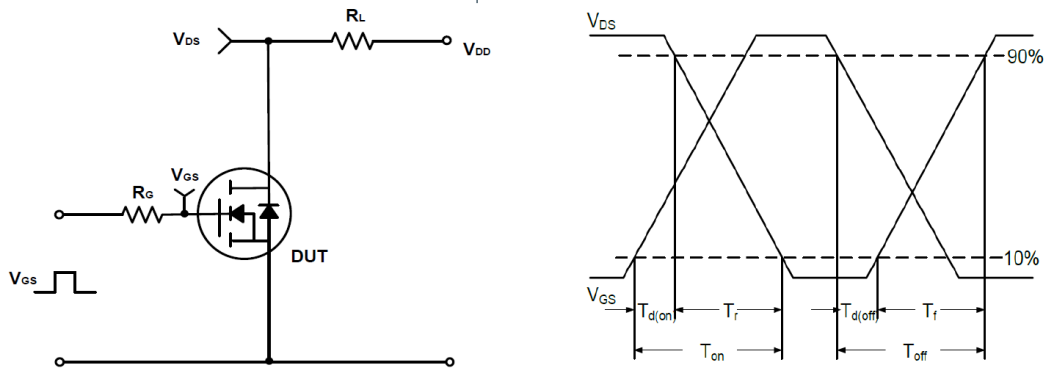
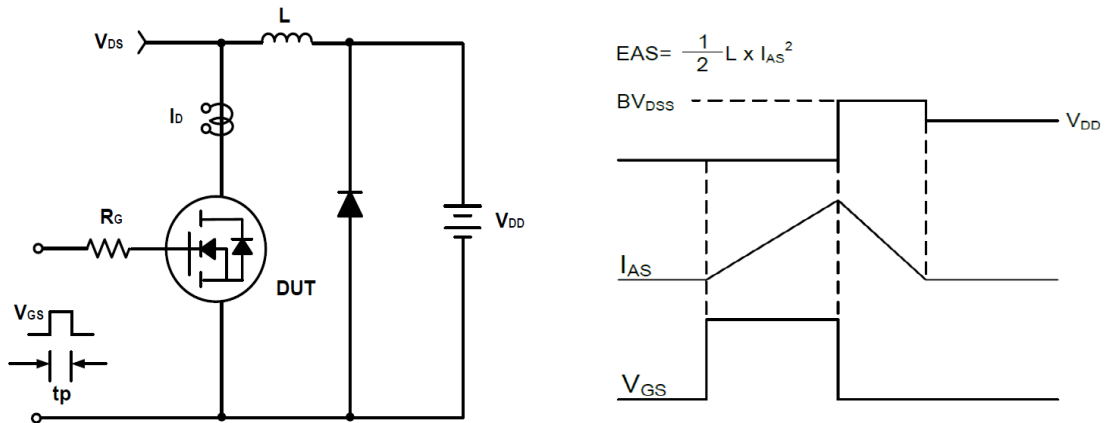

Figure10: Square Wave Pulse Duration (sec)

40V/80A N-Channel Advanced Power MOSFET
Test Circuit and Waveform:

Figure A Gate Charge Test Circuit & Waveforms

Figure B Switching Test Circuit & Waveforms

Figure C Unclamped Inductive Switching Circuit & Waveforms

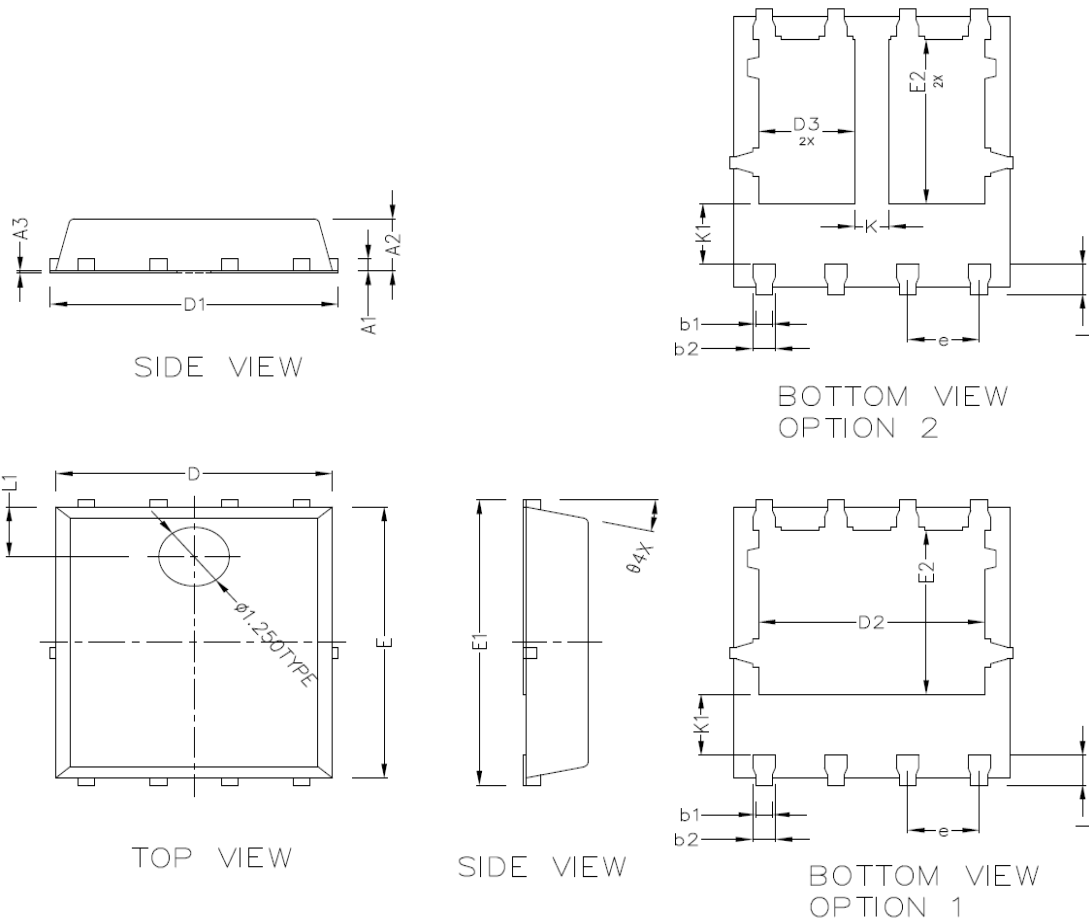

40V/80A N-Channel Advanced Power MOSFET

PDFN5X6-8L Package Outline Dimensions (Units: mm)



COMMON DIMENSIONS (UNITS OF MEASURE IS mm)			
	MIN	NORMAL	MAX
A1	0.254 BSC		
A2	1.000	1.100	1.200
A3	0.006	-	0.020
b1	0.250	0.300	0.360
b2	0.350	0.400	0.460
D	4.800	4.900	5.000
D1	5.000	5.100	5.200
D2	3.910	4.010	4.110
D3	1.605	1.705	1.805
E	5.650	5.750	5.850
E1	5.950	6.050	6.150
E2	3.375	3.475	3.575
e	1.270 TYPE		
L	0.630	0.630	0.730
L1	1.00REF		
θ	13° TYPE		
K	0.600 REF		
K1	1.235 REF		