

**30V/10A N-Channel Enhancement Mode MOSFET****Features**

- Improved dv/dt Capability, High Ruggedness.
- Maximum Junction Temperature Range (150°C)

BVDSS	30	V
ID	10	A
RDSON@VGS=10V	7.7	mΩ
RDSON@VGS=4.5V	12.5	mΩ

Applications

- High Side Load Switch
- Battery Switch
- Optimized for Power Management Applications for Portable Products, such as wireless charger, Media Tablets, PMP, DSC, GPS, and Others

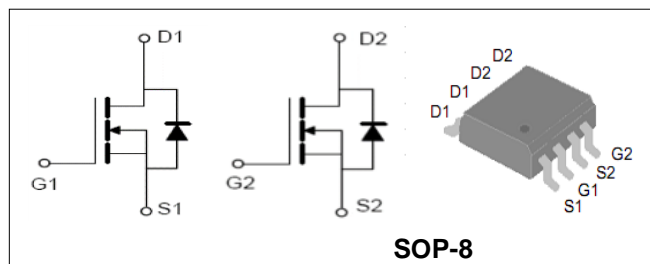
**Order Information**

Product	Package	Marking	Reel Size	Reel	Carton
PTS3210	SOP-8	PTS3210	13inch	3000PCS	48000PCS

Absolute Maximum Ratings

Symbol	Parameter	Rating	Unit
Common Ratings (TC=25°C Unless Otherwise Noted)			
$V_{(BR)DSS}$	Drain-Source Breakdown Voltage	30	V
V_{GS}	Gate-Source Voltage	±20	V
T_J	Maximum Junction Temperature	150	°C
T_{STG}	Storage Temperature Range	-55 to 150	°C
I_S	Diode Continuous Forward Current	$T_A = 25^\circ\text{C}$ 10	A
Mounted on Large Heat Sink			
I_{DM}	Pulse Drain Current Tested (Silicon Limit) (Note1)	$T_A = 25^\circ\text{C}$ 40	A
I_D	Continuous Drain current	$T_A = 25^\circ\text{C}$ 10	A
P_D	Maximum Power Dissipation	$T_A = 25^\circ\text{C}$ 2	W
$R_{\theta JA}$	Thermal Resistance Junction-to-Ambient (Note2)	62.5	°C/W



30V/10A N-Channel Enhancement Mode MOSFET

Symbol	Parameter	Condition	Min.	Typ.	Max.	Unit
Static Electrical Characteristics @ T_J = 25°C (unless otherwise stated)						
V _{(BR)DSS}	Drain- Source Breakdown Voltage	VGS=0V ID=250μA	30	--	--	V
I _{DSS}	Zero Gate Voltage Drain current	VDS=30V,VGS=0V	--	--	1	μA
I _{GSS}	Gate-Body Leakage Current	VGS=±20V,VDS=0V	--	--	±100	μA
V _{GS(TH)}	Gate Threshold Voltage	VDS=VGS,ID=250μA	1	--	2.5	V
R _{DS(ON)}	Drain-Source On-State Resistance (Note3)	VGS=10V, ID=10A	--	7.7	13	mΩ
		VGS=4.5V, ID=10A	--	12.5	16	mΩ
Dynamic Electrical Characteristics @ T_J = 25°C (unless otherwise stated) (Note4)						
C _{iss}	Input Capacitance	VDS=15V, VGS=0V, F=1MHz	--	2097	--	pF
C _{oss}	Output Capacitance		--	170	--	pF
C _{rss}	Reverse Transfer Capacitance		--	126	--	pF
Q _g	Total Gate Charge	VDS=10V, ID=10A, VGS=10V	--	23	--	nC
Q _{gs}	Gate-Source Charge		--	7	--	nC
Q _{gd}	Gate-Drain Charge		--	5	--	nC
Switching Characteristics (Note5)						
t _{d(on)}	Turn-on Delay Time	VDS=10V, ID=10A, RG=2.7Ω, VGS=10V	--	14	--	nS
t _r	Turn-on Rise Time		--	9	--	nS
t _{d(off)}	Turn-off Delay Time		--	39	--	nS
t _f	Turn-off Fall Time		--	7	--	nS
Source- Drain Diode Characteristics @ T_J = 25°C (unless otherwise stated)						
V _{SD}	Forward on voltage	IS=4A,VGS=0V	--	--	1.2	V

Note:

1. Repetitive Rating: Pulse width limited by maximum junction temperature.
2. Surface Mounted on FR4 Board, t ≤ 10 sec.
3. Pulse Test: pulse width ≤ 300 us, duty cycle ≤ 2%.
4. Guranteed by design, not subject to production testing.



30V/10A N-Channel Enhancement Mode MOSFET

Typical Characteristics

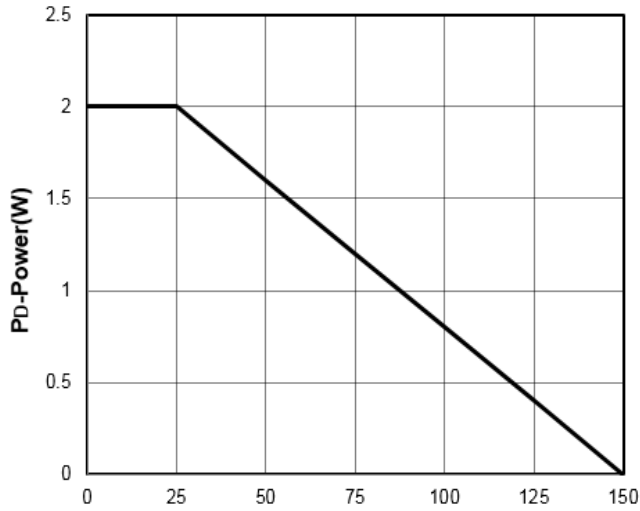

Figure1: T_J Junction Temperature (°C)

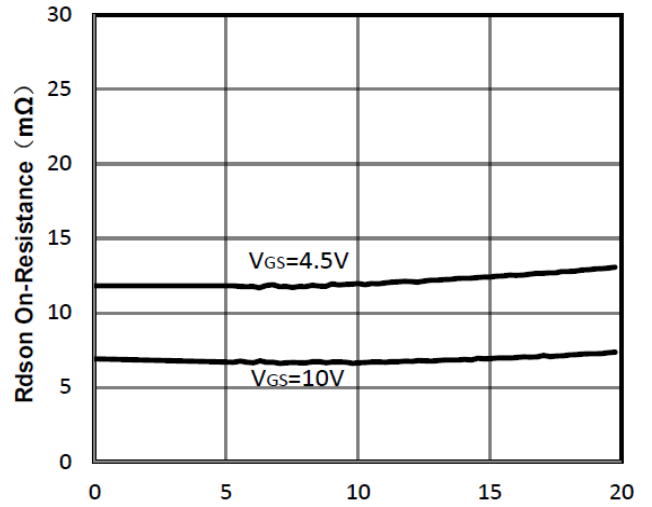

Figure2: I_D Drain Current (A)

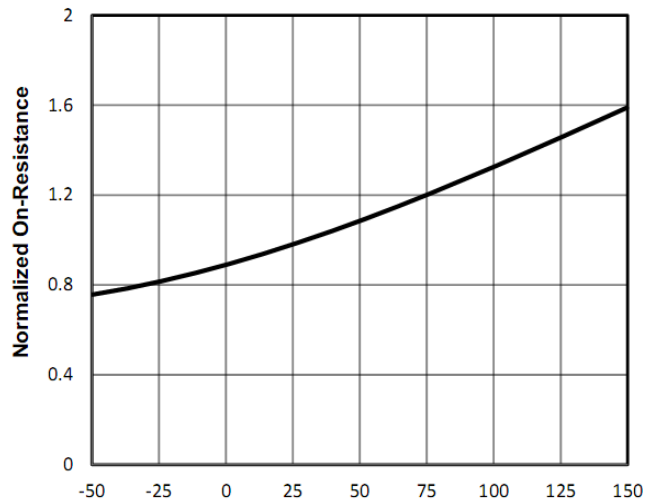

Figure3: T_J Junction Temperature (°C)

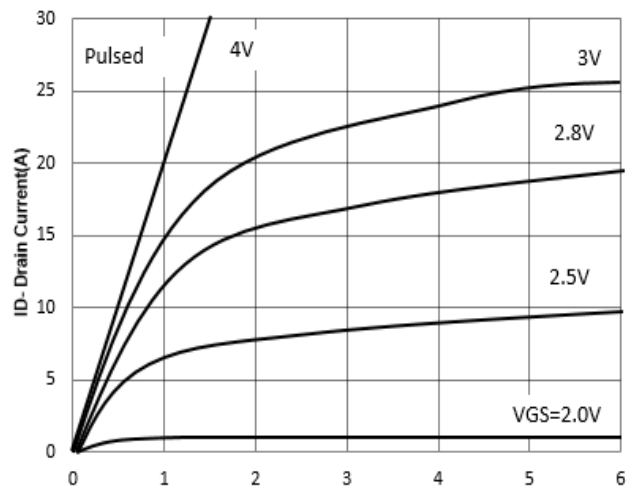

Figure4: V_{DS} Drain-Source Voltage (V)

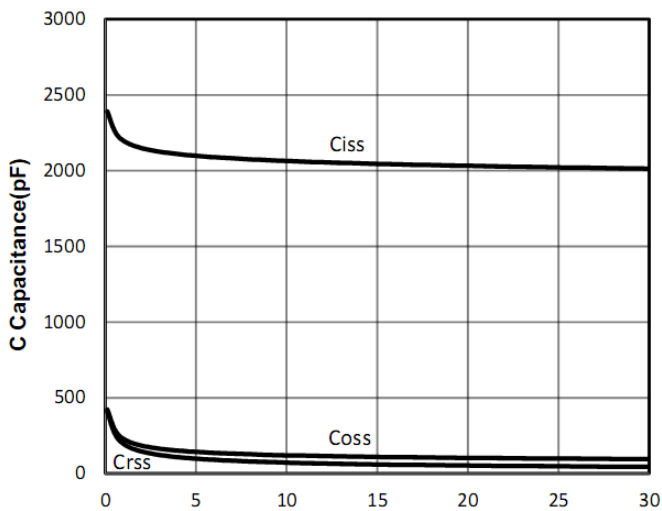

Figure5: V_{DS} Drain-Source Voltage (V)

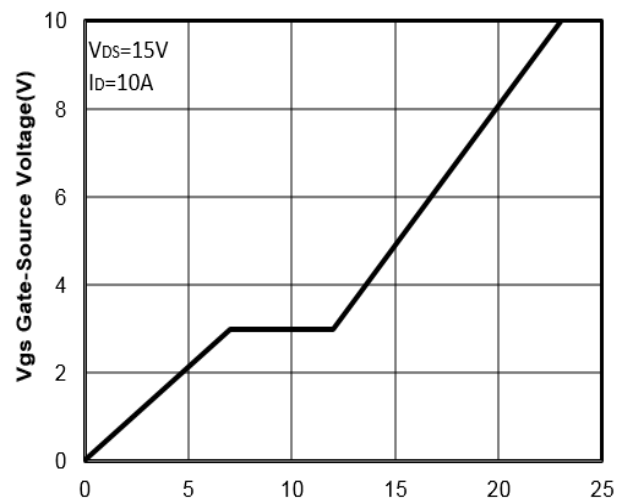

Figure6: Q_g Gate Charge (nC)



30V/10A N-Channel Enhancement Mode MOSFET

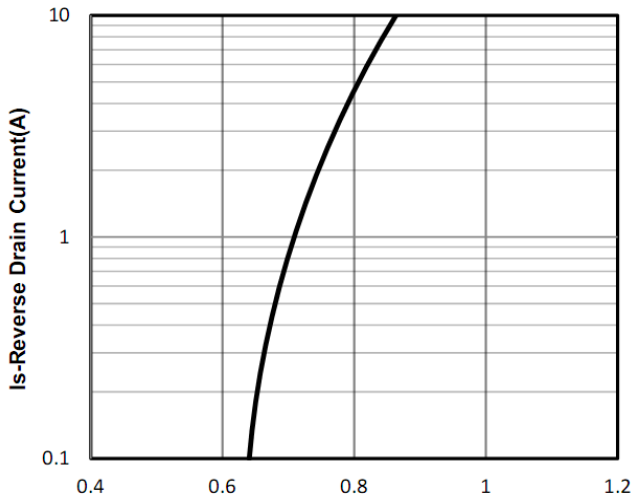

Figure7: Vsd Source-Drain Voltage (V)

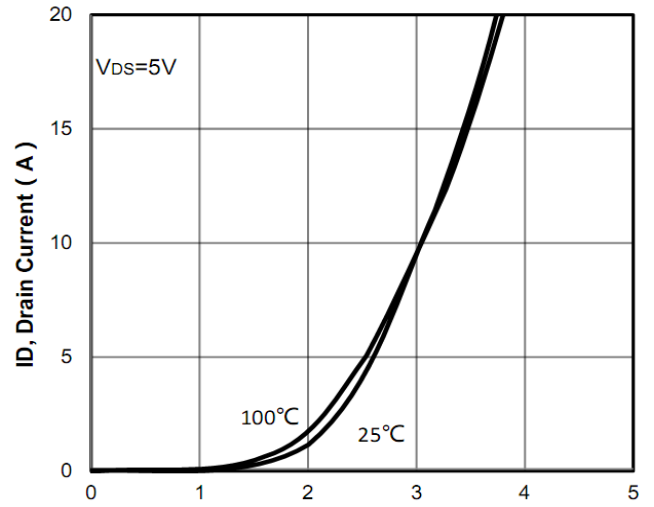

Figure8: Vgs Gate-Source Voltage (V)

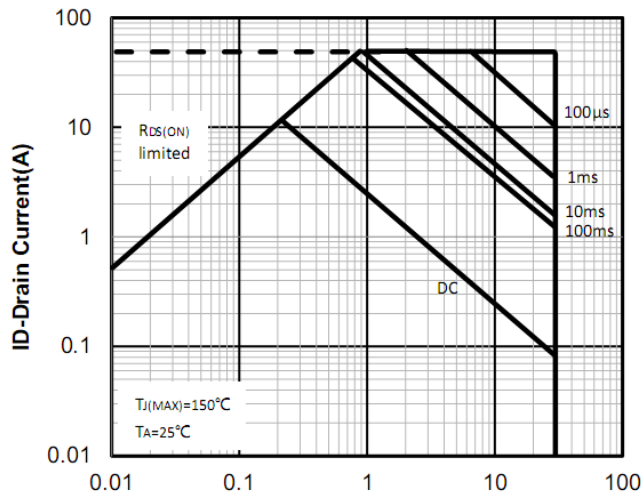

Figure9: Vds Drain -Source Voltage (V)

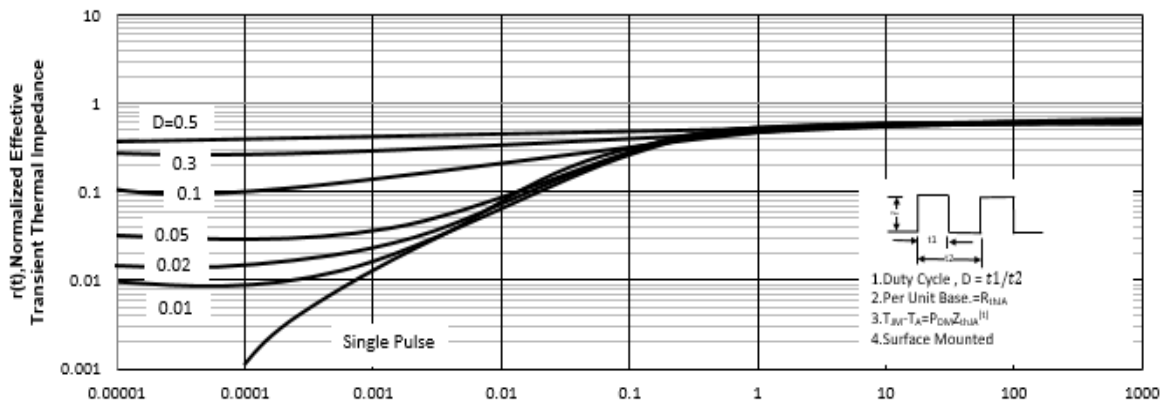

Figure10: Square Wave Pulse Duration (sec)

30V/10A N-Channel Enhancement Mode MOSFET

Test Circuit and Waveform:

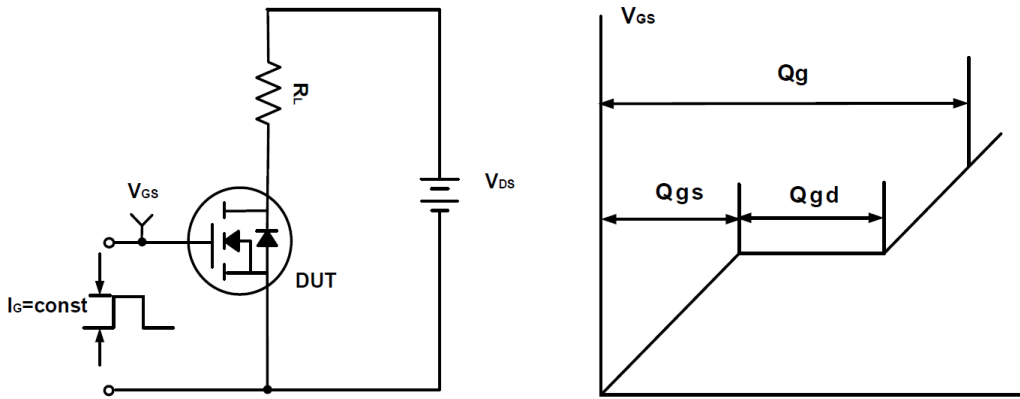

Figure A Gate Charge Test Circuit & Waveforms

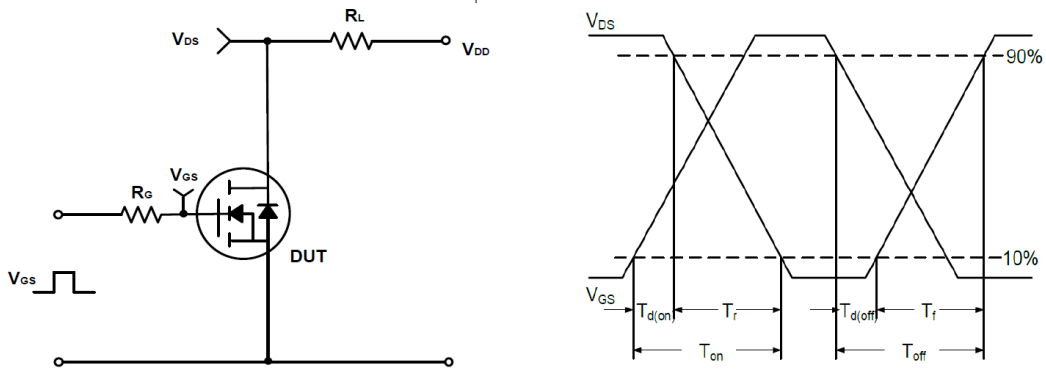

Figure B Switching Test Circuit & Waveforms

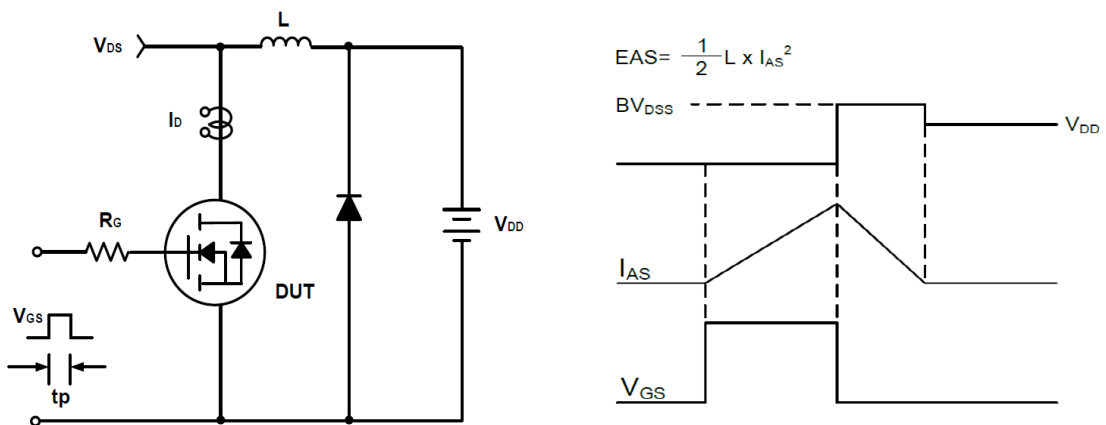
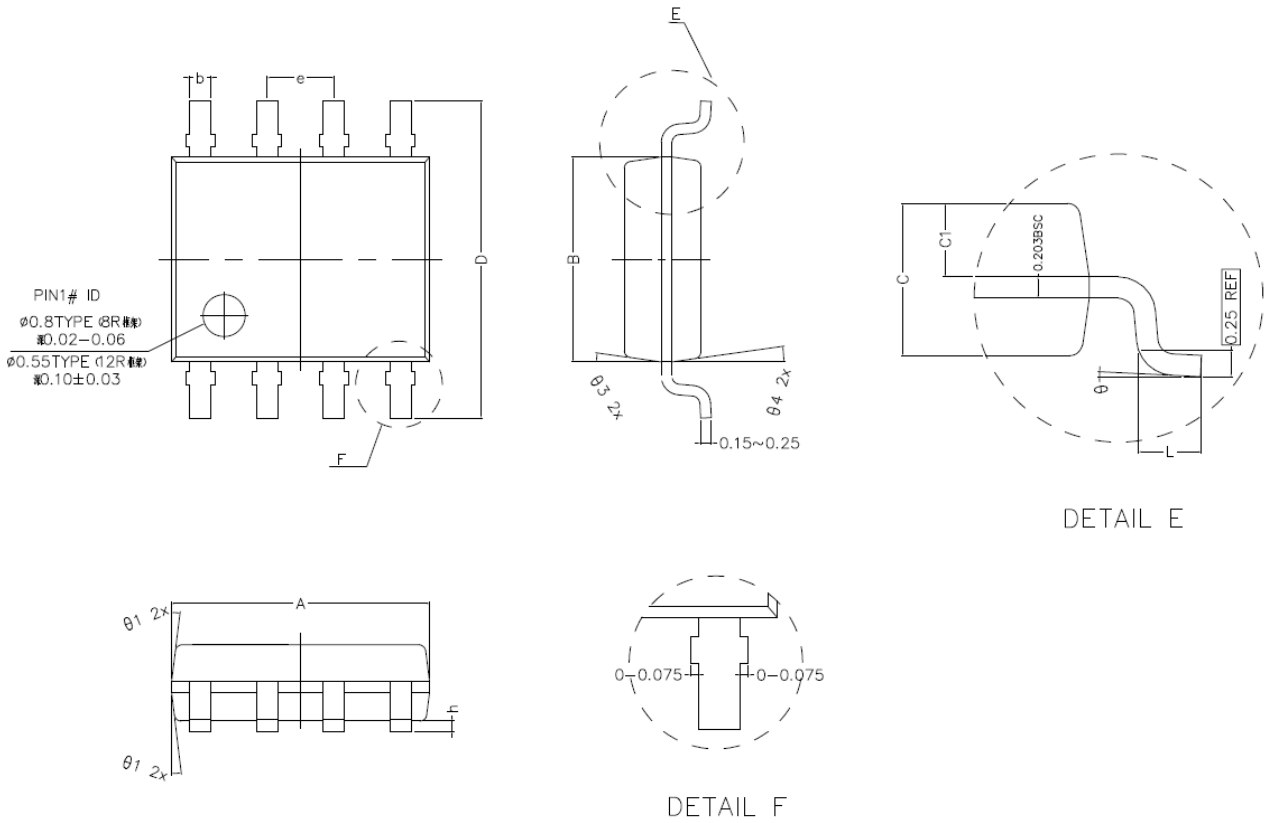

Figure C Unclamped Inductive Switching Circuit & Waveforms

30V/10A N-Channel Enhancement Mode MOSFET
SOP-8 Package Outline Dimensions (Units: mm)

COMMON DIMENSIONS (UNITS OF MEASURE IS mm)			
	MIN	NORMAL	MAX
A	4.800	4.900	5.000
B	3.800	3.900	4.000
C	1.350	1.450	1.550
C1	0.650	0.700	0.750
D	5.900	6.100	6.300
L	0.500	0.600	0.700
b	0.350	0.400	0.450
h	0.050	0.150	0.250
e	1.270TYPE		
θ ₁	7° TYPE(8R)		12° TYPE(12R)
θ ₂	7° TYPE(8R)		10° TYPE(12R)
θ ₃	8° TYPE(8R)		12° TYPE(12R)
θ ₄	8° TYPE(8R)		10° TYPE(12R)
θ	0° ~ 8°		