



## 100V/2.6A N-Channel Advanced Power MOSFET

### Features

- High density cell design for ultra low Rdson

### Applications

- Power switching application
- Hard switched and high frequency circuits
- Uninterruptible power supply

BVDSS	100	V
ID	2.6	A
RDSON@VGS=10V	115	mΩ
RDSON@VGS=4.5V	135	mΩ

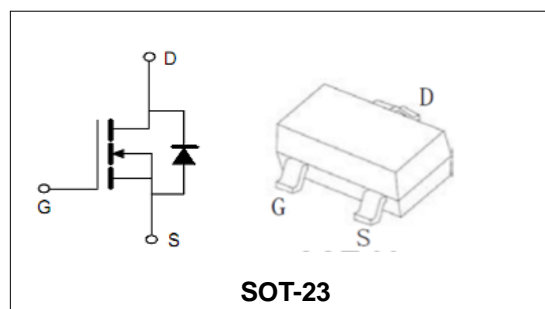

### Order Information

Product	Package	Marking	Reel Size	Reel	Carton
PTL03N10	SOT-23	3N10	7inch	3000PCS	180000PCS

### Absolute Maximum Ratings

Symbol	Parameter	Rating	Unit	
<b>Common Ratings (TC=25°C Unless Otherwise Noted)</b>				
$V_{(BR)DSS}$	Drain-Source Breakdown Voltage	100	V	
$V_{GS}$	Gate-Source Voltage	±20	V	
$T_J$	Maximum Junction Temperature	150	°C	
$T_{STG}$	Storage Temperature Range	-55 to 150	°C	
$I_S$	Diode Continuous Forward Current	TC =25°C	2.6	A
<b>Mounted on Large Heat Sink</b>				
$I_{DM}$	Pulse Drain Current Tested (Silicon Limit) (Note1)	TC =25°C	10	A
$I_D$	Continuous Drain current	TC =25°C	2.6	A
$P_D$	Maximum Power Dissipation	TC =25°C	1	W
$R_{θJA}$	Thermal Resistance Junction-to-Ambient (Note2)		125	°C/W



## 100V/2.6A N-Channel Advanced Power MOSFET

Symbol	Parameter	Condition	Min.	Typ.	Max.	Unit
<b>Static Electrical Characteristics @ T<sub>J</sub> = 25°C (unless otherwise stated)</b>						
V <sub>(BR)DSS</sub>	Drain- Source Breakdown Voltage	VGS=0V ID=250μA	100	--	--	V
I <sub>DSS</sub>	Zero Gate Voltage Drain current	VDS=100V,VGS=0V	--	--	1	μA
I <sub>GSS</sub>	Gate-Body Leakage Current	VGS=±20V,VDS=0V	--	--	±100	nA
V <sub>GS(TH)</sub>	Gate Threshold Voltage	VDS=VGS,ID=250μA	1	1.8	3	V
R <sub>DS(ON)</sub>	Drain-Source On-State Resistance (Note3)	VGS=10V, ID=2.5A	--	115	165	mΩ
		VGS=4.5V, ID=1.5A	--	135	180	mΩ
<b>Dynamic Electrical Characteristics @ T<sub>J</sub> = 25°C (unless otherwise stated) (Note4)</b>						
C <sub>iss</sub>	Input Capacitance	VDS=30V, VGS=0V, F=1MHz	--	405	--	pF
C <sub>oss</sub>	Output Capacitance		--	36	--	pF
C <sub>rss</sub>	Reverse Transfer Capacitance		--	18	--	pF
Q <sub>g</sub>	Total Gate Charge	VGS=10V, VDS=30V, ID=1 A	--	9	--	nC
Q <sub>gs</sub>	Gate-Source Charge		--	1.5	--	nC
Q <sub>gd</sub>	Gate-Drain Charge		--	2.1	--	nC
<b>Switching Characteristics (Note4)</b>						
t <sub>d(on)</sub>	Turn-on Delay Time	VDS=30V, ID=1A, RG=6.8Ω, VGS=10V	--	9	--	nS
t <sub>r</sub>	Turn-on Rise Time		--	8.1	--	nS
t <sub>d(off)</sub>	Turn-off Delay Time		--	20	--	nS
t <sub>f</sub>	Turn-off Fall Time		--	13.5	--	nS
<b>Source- Drain Diode Characteristics @ T<sub>J</sub> = 25°C (unless otherwise stated)</b>						
V <sub>SD</sub>	Forward on voltage	IS=2.5A,VGS=0V	--	--	1.3	V

Note:

1. Repetitive Rating: Pulse width limited by maximum junction temperature.
2. Surface Mounted on FR4 Board, t ≤ 10 sec.
3. Pulse Test: pulse width ≤ 300 us, duty cycle ≤ 2%.
4. Guranteed by design, not subject to production testing.



Typical Characteristics

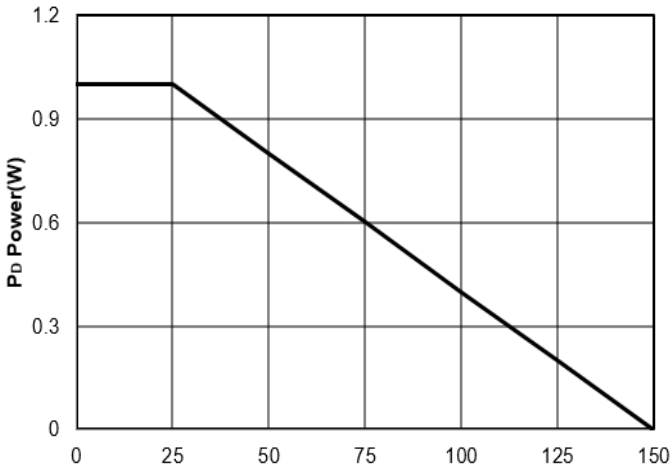

Figure1: Tj Junction Temperature (°C)

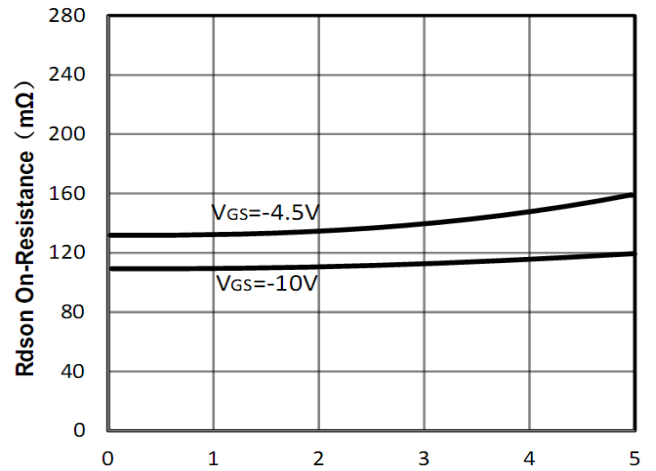

Figure2: Id Drain Current (A)

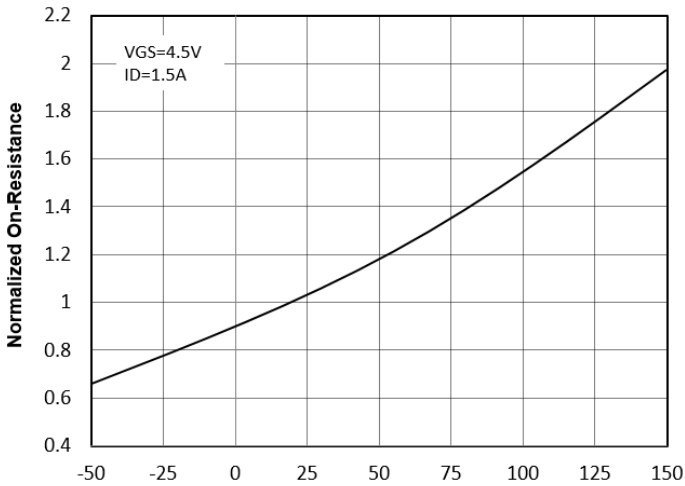

Figure3: Tj Junction Temperature (°C)

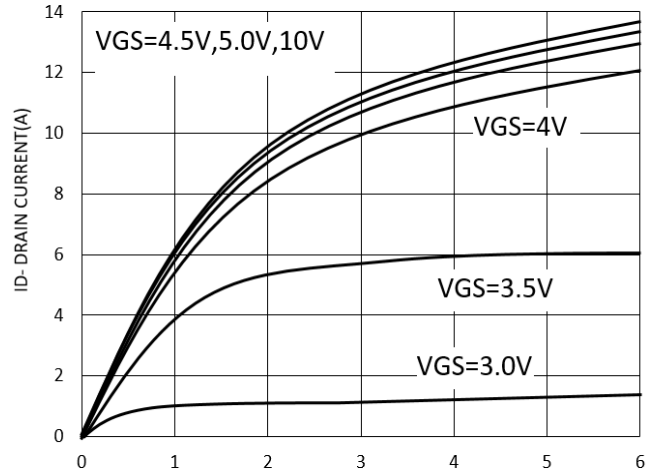

Figure4: Vds Drain-Source Voltage (V)

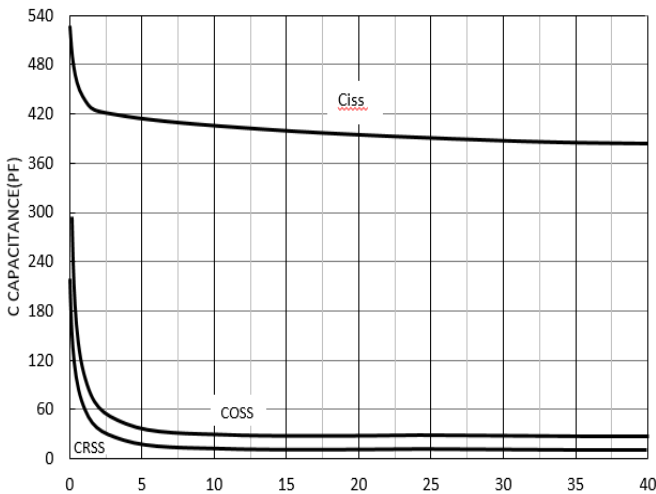

Figure5: Vds Drain-Source Voltage (V)

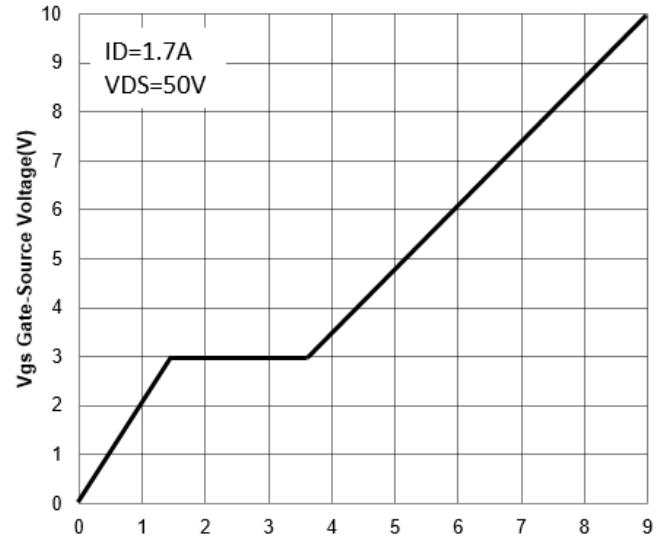

Figure6: Qg Gate Charge (nC)



100V/2.6A N-Channel Advanced Power MOSFET

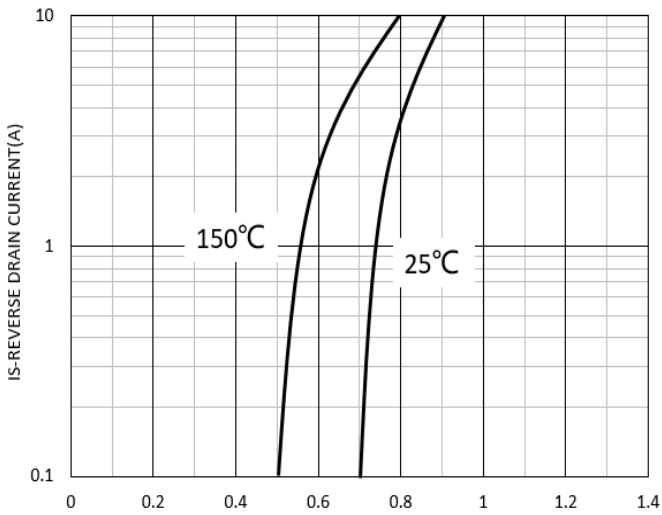

Figure7: Vsd Source-Drain Voltage (V)

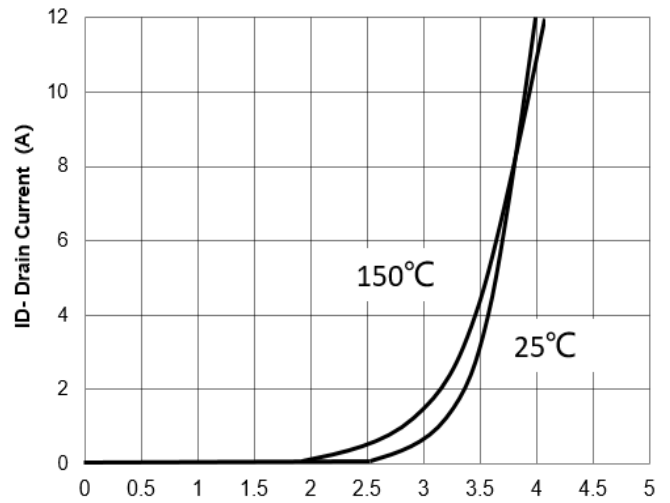

Figure8: Vgs Gate-Source Voltage (V)

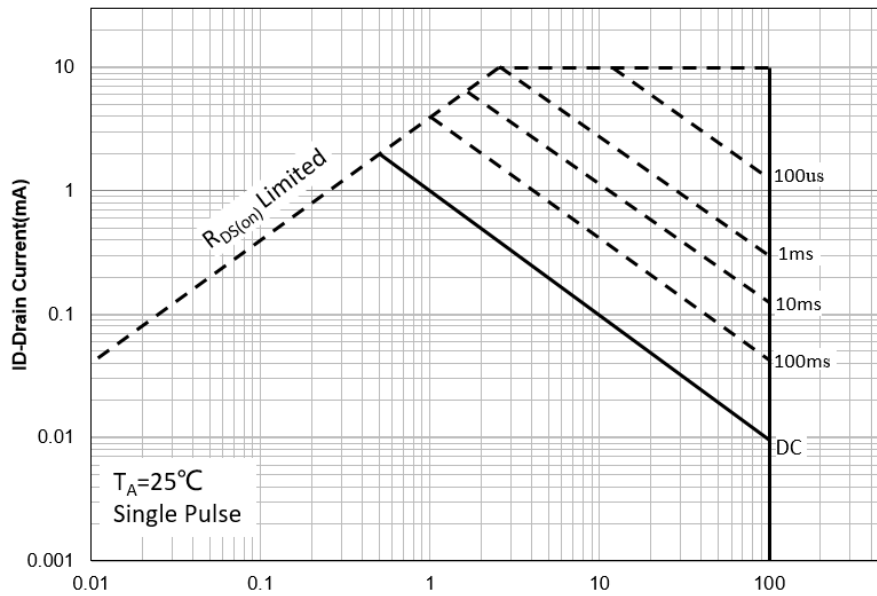

Figure9: Vsd Drain -Source Voltage (V)

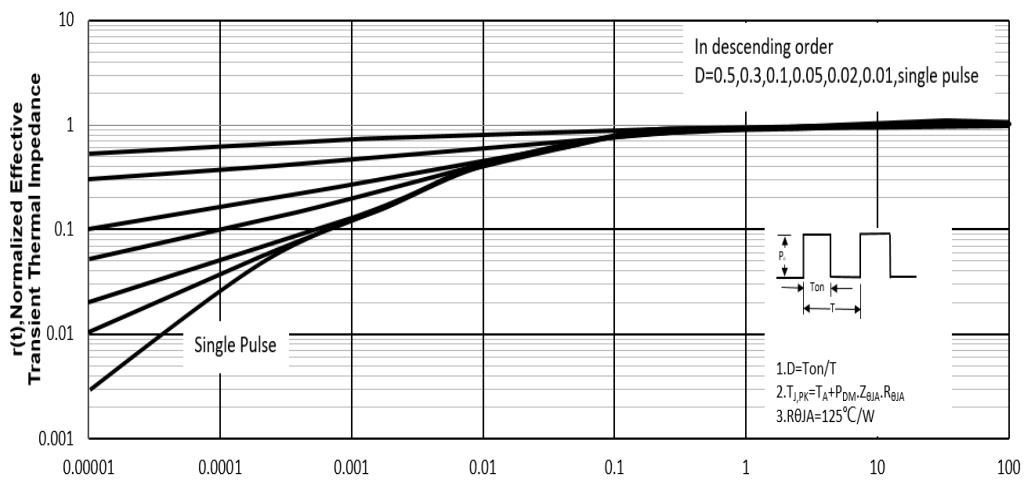
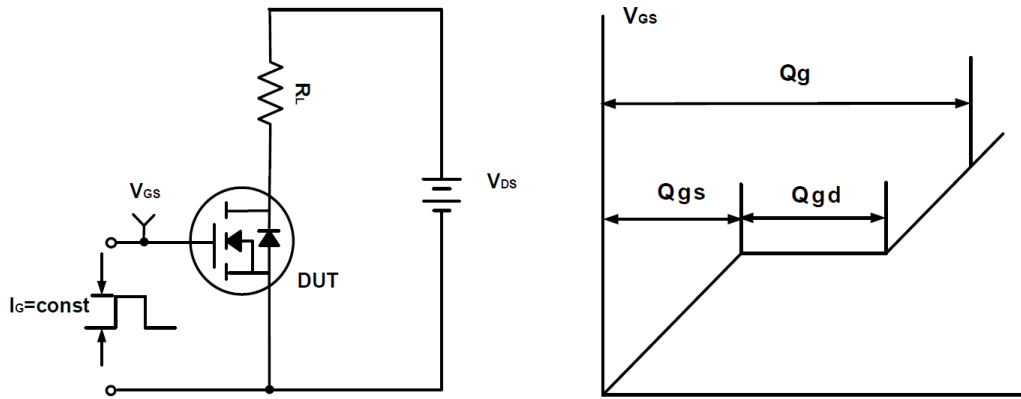
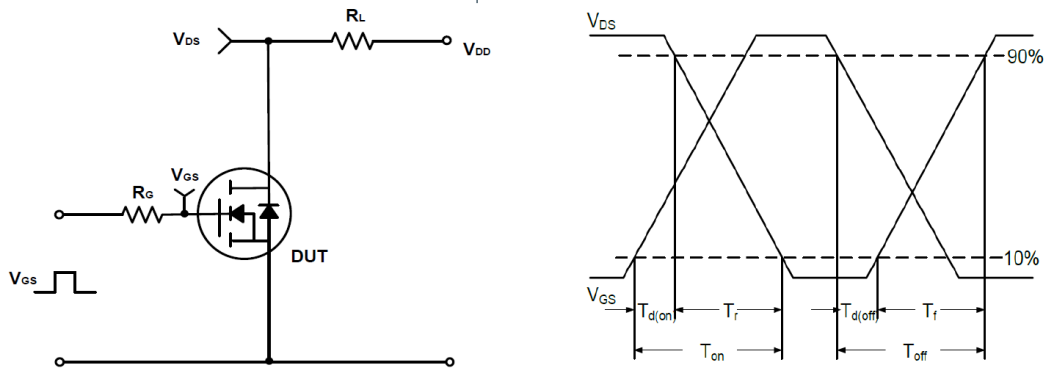
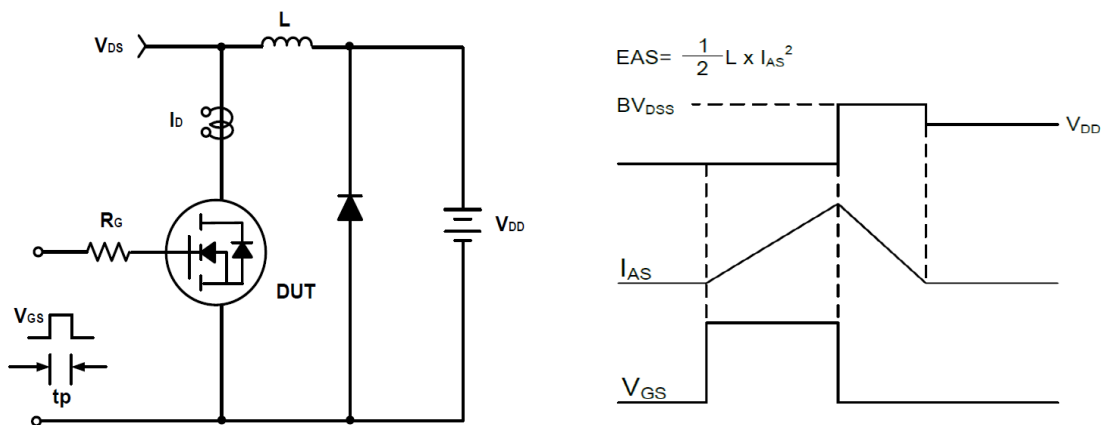

Figure10: Square Wave Pulse Duration (sec)

**100V/2.6A N-Channel Advanced Power MOSFET**
**Test Circuit and Waveform:**

**Figure A Gate Charge Test Circuit & Waveforms**

**Figure B Switching Test Circuit & Waveforms**

**Figure C Unclamped Inductive Switching Circuit & Waveforms**

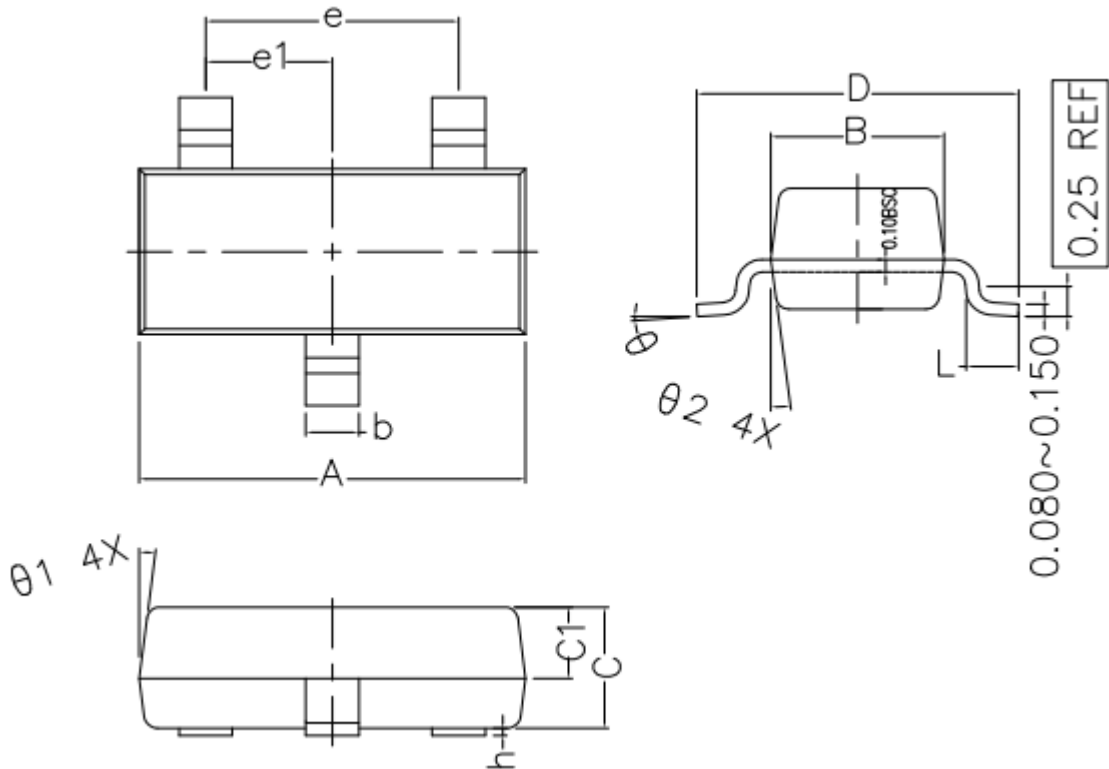

100V/2.6A N-Channel Advanced Power MOSFET

SOT-23 Package Outline Dimensions (Units: mm)



COMMON DIMENSIONS (UNITS OF MEASURE IS mm)			
	MIN	NORMAL	MAX
A	2.800	2.900	3.000
B	1.200	1.300	1.400
C	0.900	1.000	1.100
C1	0.500	0.550	0.600
D	2.250	2.400	2.550
L	0.300	0.400	0.500
h	0.010	0.050	0.100
b	0.300	0.400	0.500
e	1.90 TYPE		
e1	0.95 TYPE		
theta <sub>1</sub>	7° TYPE		
theta <sub>2</sub>	7° TYPE		
theta	0° ~ 7°		