



60V/0.115A N-Channel Advanced Power MOSFET

Features

- Lead free product is acquired
- Surface mount package

Applications

- Direct logic-level interface: TTL/CMOS
- Drivers: relays, solenoids, lamps, hammers, display, memories, transistors, etc.
- Battery operated systems
- Solid-state relays

BVDSS	60	V
ID	0.115	A
RDSON@VGS=10V	1	Ω
RDSON@VGS=5V	1.3	Ω

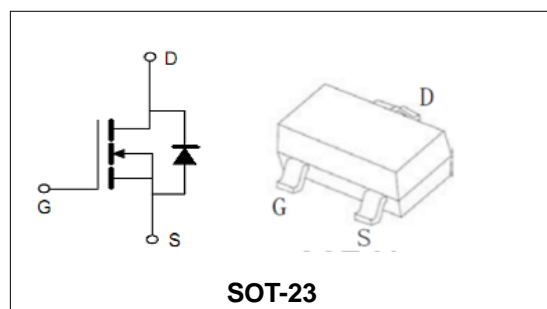

Order Information

Product	Package	Marking	Reel Size	Reel	Carton
2N7002	SOT-23	7002	7inch	3000PCS	180000PCS

Absolute Maximum Ratings

Symbol	Parameter	Rating	Unit	
Common Ratings (TC=25°C Unless Otherwise Noted)				
$V_{(BR)DSS}$	Drain-Source Breakdown Voltage	60	V	
V_{GS}	Gate-Source Voltage	±20	V	
T_J	Maximum Junction Temperature	150	°C	
T_{STG}	Storage Temperature Range	-55 to 150	°C	
I_S	Diode Continuous Forward Current	$T_A = 25^\circ\text{C}$	0.115	A
Mounted on Large Heat Sink				
I_{DM}	Pulse Drain Current Tested (Silicon Limit) (Note1)	$T_A = 25^\circ\text{C}$	0.5	A
I_D	Continuous Drain current	$T_A = 25^\circ\text{C}$	0.115	A
P_D	Maximum Power Dissipation	$T_A = 25^\circ\text{C}$	0.225	W
$R_{\theta JA}$	Thermal Resistance Junction-to-Ambient (Note2)		556	°C/W



60V/0.115A N-Channel Advanced Power MOSFET

Symbol	Parameter	Condition	Min.	Typ.	Max.	Unit
Static Electrical Characteristics @ T_J = 25°C (unless otherwise stated)						
V _{(BR)DSS}	Drain- Source Breakdown Voltage	VGS=0V ID=250μA	60	--	--	V
I _{DSS}	Zero Gate Voltage Drain current	VDS=60V,VGS=0V	--	--	1	μA
I _{GSS}	Gate-Body Leakage Current	VGS=±20V,VDS=0V	--	--	±10	μA
V _{GS(TH)}	Gate Threshold Voltage	VDS=VGS,ID=250μA	1	1.7	2.5	V
R _{DS(ON)}	Drain-Source On-State Resistance (Note3)	VGS=5V, ID=0.05A	--	1.3	4	Ω
		VGS=10V, ID=0.5A	--	1	3	Ω
G _{FS}	Forward Transconductance	VDS=10V,ID=0.2A	0.08	--	--	S
V _{DS(ON)}	Drain-Source On-State Voltage	VGS=5V, ID=0.05A	--	--	0.375	V
		VGS=10V, ID=0.5A	--	--	3.75	V
Dynamic Electrical Characteristics @ T_J = 25°C (unless otherwise stated) (Note3)						
C _{iss}	Input Capacitance	VDS=25V, VGS=0V, F=1MHz	--	20	--	pF
C _{oss}	Output Capacitance		--	10	--	pF
C _{rss}	Reverse Transfer Capacitance		--	3.6	--	pF
Switching Characteristics (Note4)						
t _{d(on)}	Turn-on Delay Time	VDS=25V, ID=0.5A, RL=50Ω, RG=25Ω, VGS=10V	--	20	--	nS
t _{d(off)}	Turn-off Delay Time		--	40	--	nS
Source- Drain Diode Characteristics @ T_J = 25°C (unless otherwise stated)						
V _{SD}	Forward on voltage	IS=0.115A,VGS=0V	--	--	1.2	V

Note:

1. Repetitive Rating: Pulse width limited by maximum junction temperature.
2. Surface Mounted on FR4 Board, t ≤ 10 sec.
3. Pulse Test: pulse width ≤ 300 us, duty cycle ≤ 2%.
4. Guaranteed by design, not subject to production testing.



60V/0.115A N-Channel Advanced Power MOSFET

Typical Characteristics

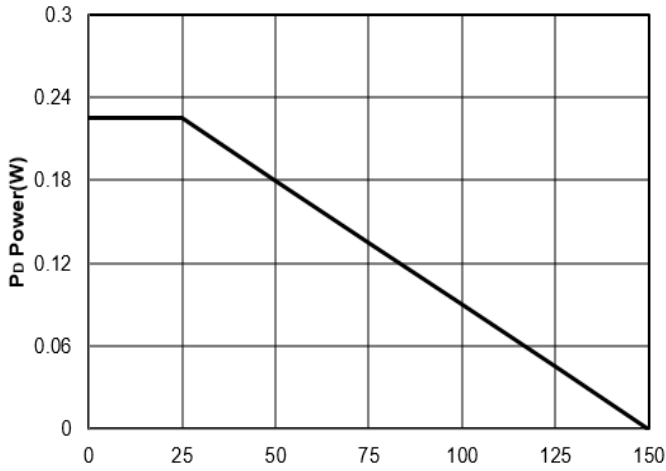

Figure1: T_J Junction Temperature (°C)

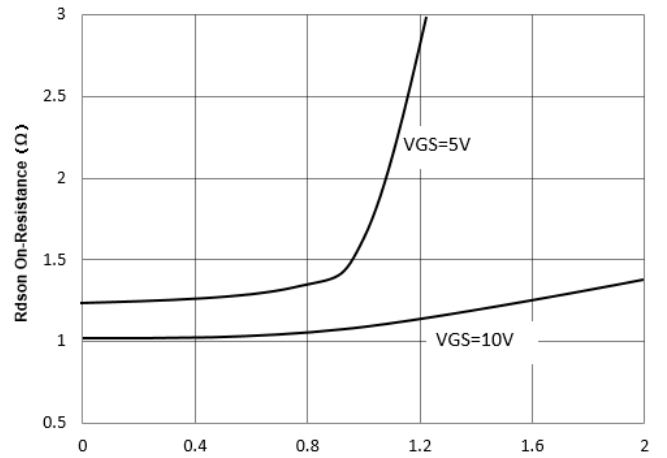

Figure2: I_D Drain Current (A)

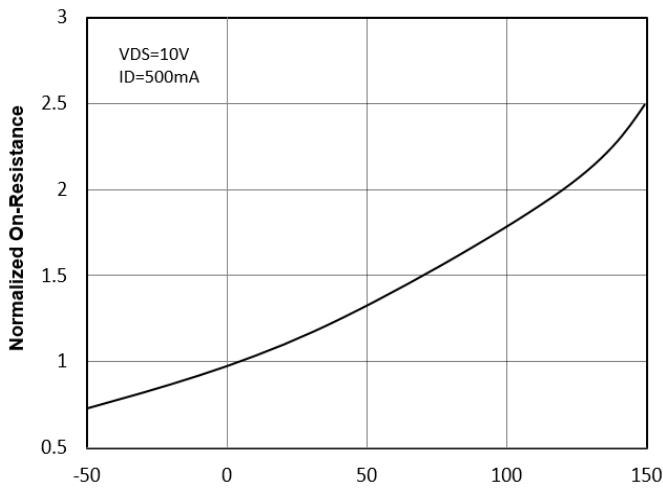

Figure3: T_J Junction Temperature (°C)

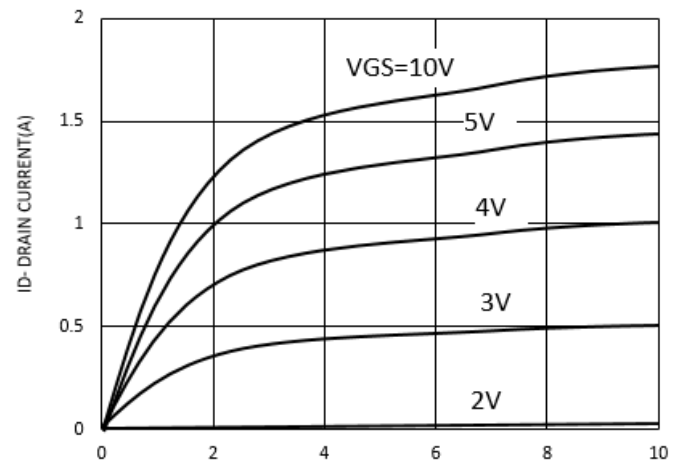

Figure4: V_{DS} Drain-Source Voltage (V)

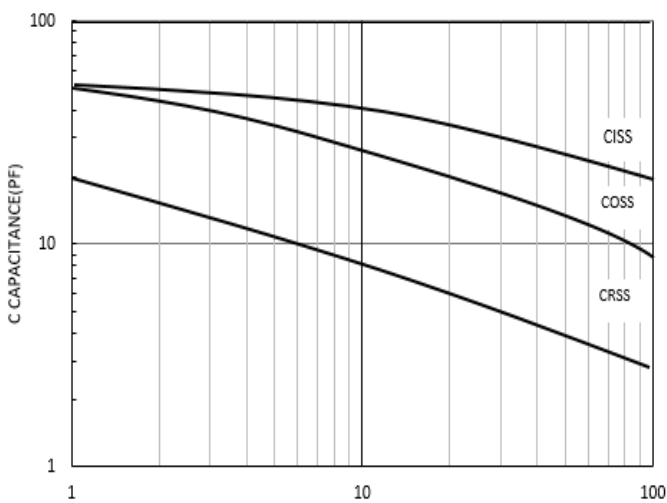

Figure5: V_{DS} Drain-Source Voltage (V)

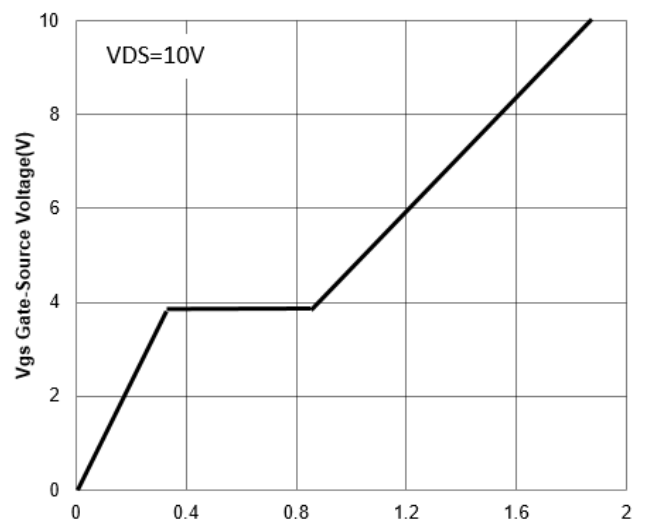

Figure6: Q_g Gate Charge (nC)



60V/0.115A N-Channel Advanced Power MOSFET

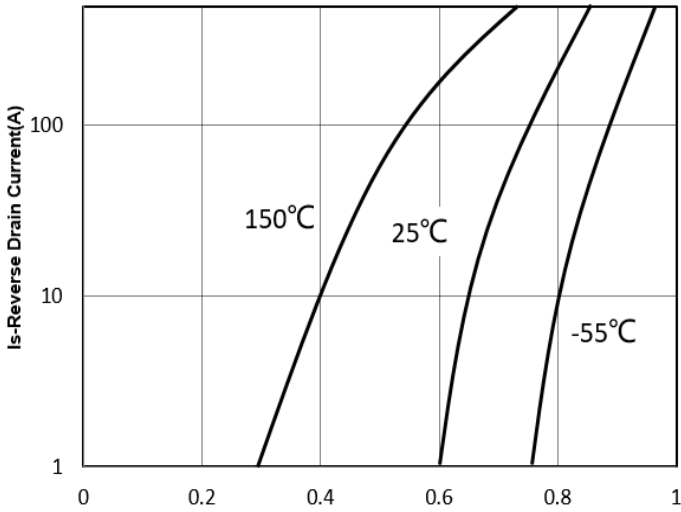

Figure7: Vsd Source-Drain Voltage (V)

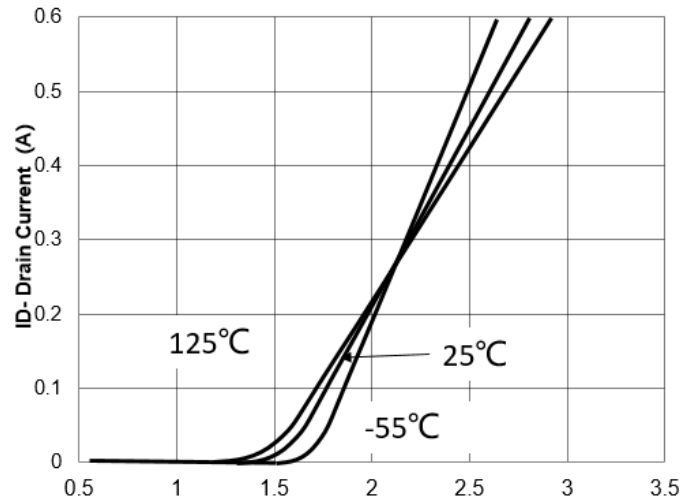

Figure8: Vgs Gate-Source Voltage (V)

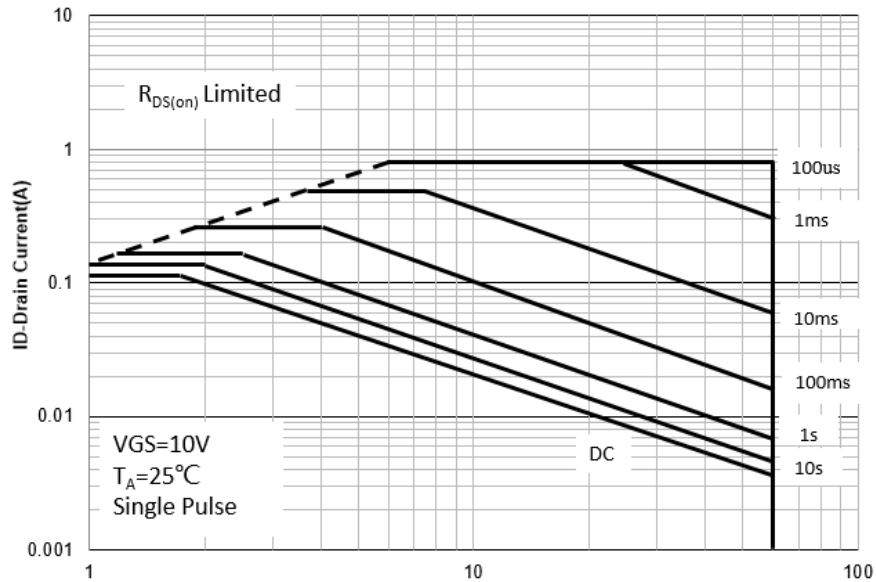

Figure9: Vds Drain -Source Voltage (V)

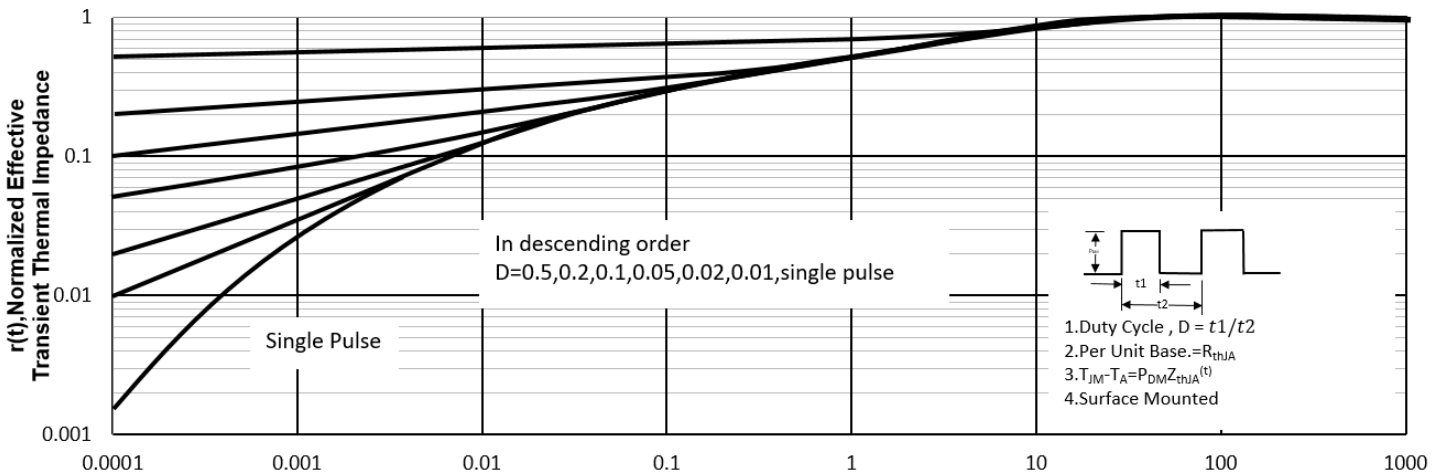
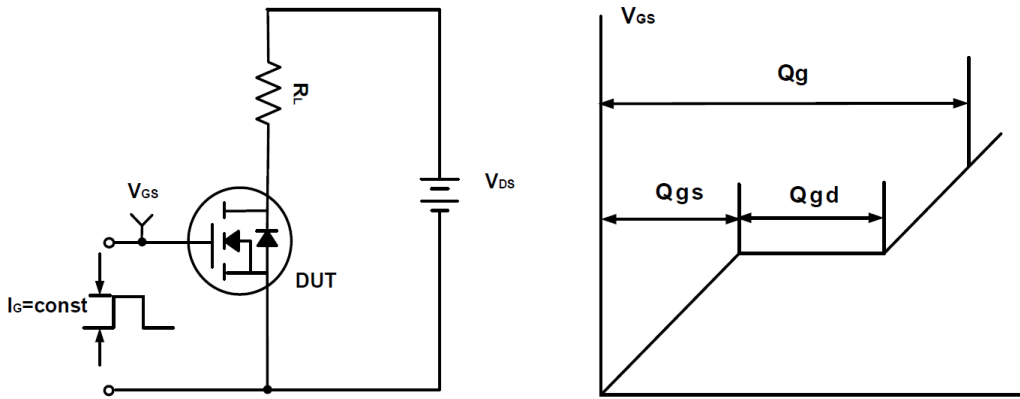
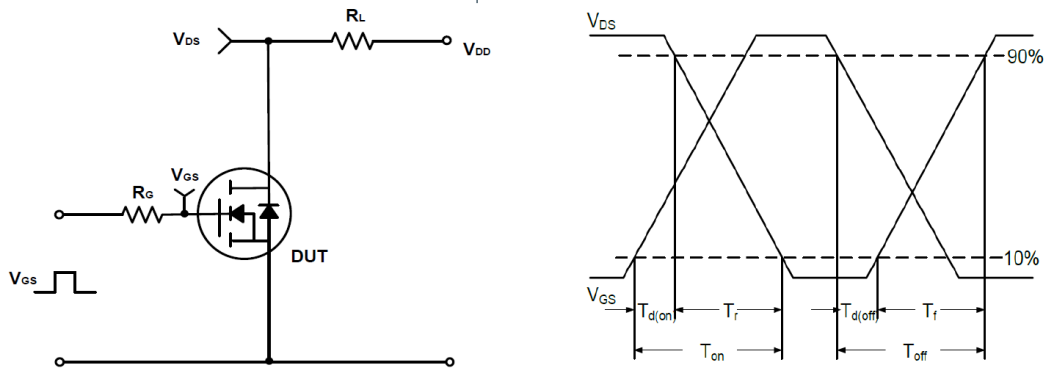
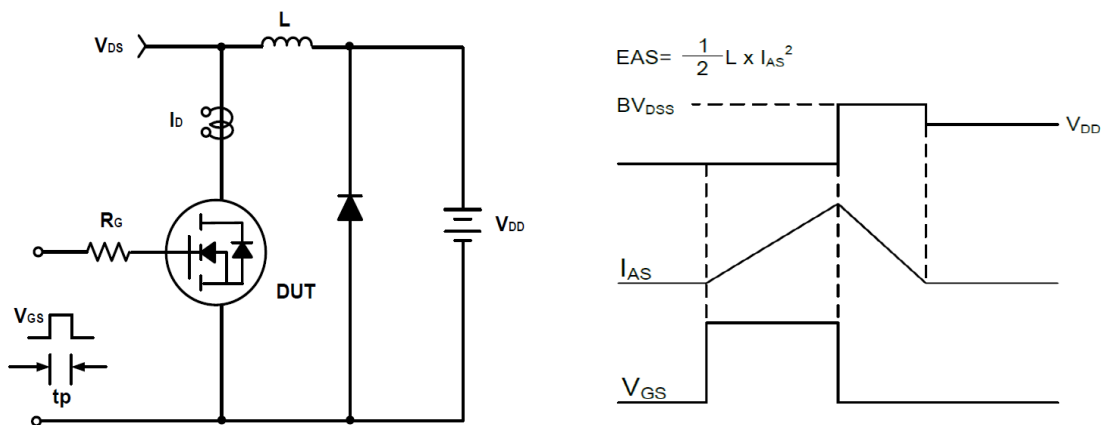
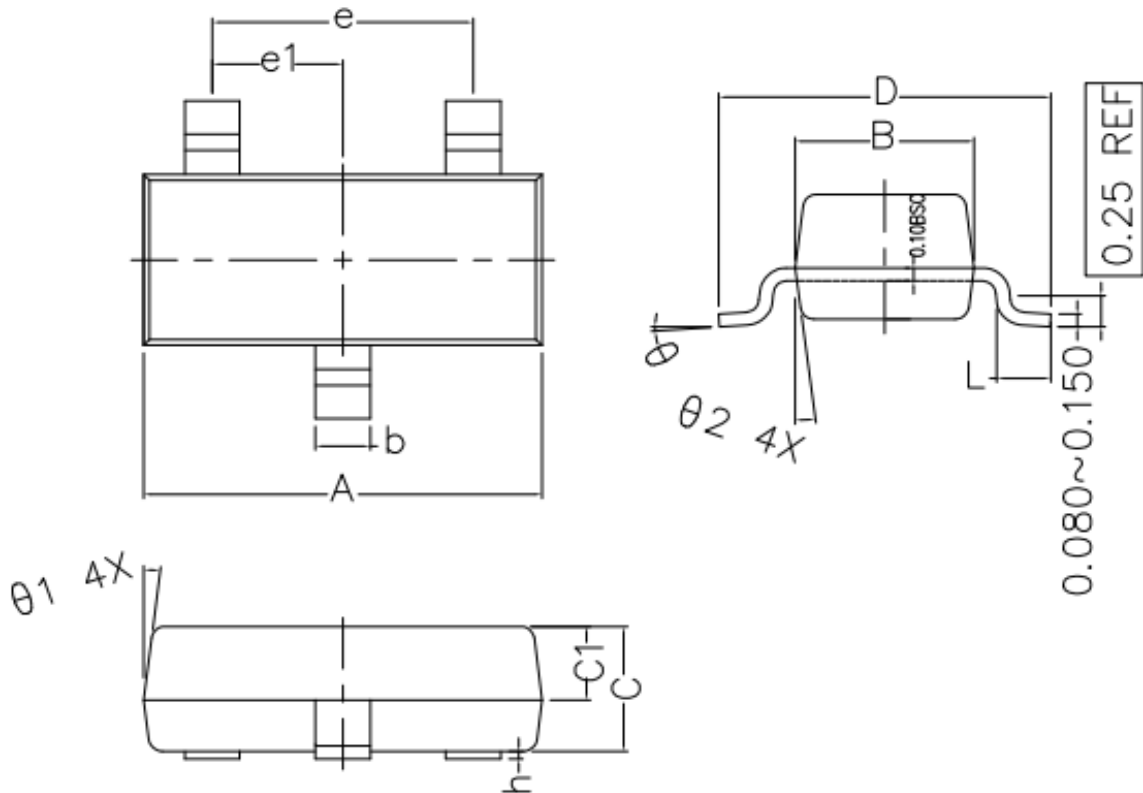

Figure10: Square Wave Pulse Duration (sec)

60V/0.115A N-Channel Advanced Power MOSFET
Test Circuit and Waveform:

Figure A Gate Charge Test Circuit & Waveforms

Figure B Switching Test Circuit & Waveforms

Figure C Unclamped Inductive Switching Circuit & Waveforms

60V/0.115A N-Channel Advanced Power MOSFET
SOT-23 Package Outline Dimensions (Units: mm)

COMMON DIMENSIONS (UNITS OF MEASURE IS mm)			
	MIN	NORMAL	MAX
A	2.800	2.900	3.000
B	1.200	1.300	1.400
C	0.900	1.000	1.100
C1	0.500	0.550	0.600
D	2.250	2.400	2.550
L	0.300	0.400	0.500
h	0.010	0.050	0.100
b	0.300	0.400	0.500
e	1.90 TYPE		
e1	0.95 TYPE		
θ_1	7° TYPE		
θ_2	7° TYPE		
θ	0° ~ 7°		