



20V/60A N-Channel Advanced Power MOSFET

Features

- Improved dv/dt Capability, High Ruggedness.
- Maximum Junction Temperature Range (150°C)
- 100% Avalanche Tested

BVDSS	20	V
ID	60	A
RDSON@VGS=4.5V	2.8	mΩ
RDSON@VGS=2.5V	3.5	mΩ

Applications

- Power factor correction (PFC)
- Switched mode power supplies(SMPS)
- Uninterruptible Power Supply (UPS)

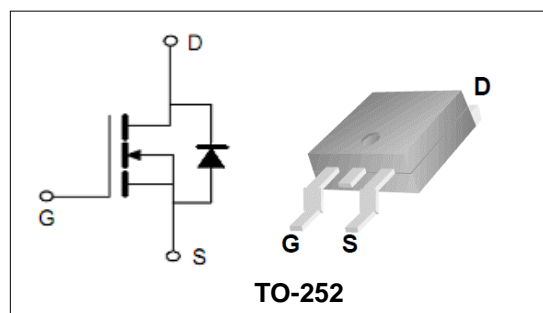

Order Information

Product	Package	Marking	Reel Size	Reel	Carton
PTD60N02	TO-252	PTD60N02	13inch	2500PCS	50000PCS

Absolute Maximum Ratings

Symbol	Parameter	Rating	Unit	
Common Ratings (TC=25°C Unless Otherwise Noted)				
$V_{(BR)DSS}$	Drain-Source Breakdown Voltage	20	V	
V_{GS}	Gate-Source Voltage	±12	V	
T_J	Maximum Junction Temperature	150	°C	
T_{STG}	Storage Temperature Range	-55 to 150	°C	
I_S	Diode Continuous Forward Current	TC =25°C	60	A
Mounted on Large Heat Sink				
E_{AS}	Single Pulse Avalanche Energy (Note1)	64	mJ	
I_{DM}	Pulse Drain Current Tested (Silicon Limit) (Note2)	TC =25°C	210	A
I_D	Continuous Drain current	TC =25°C	60	A
P_D	Maximum Power Dissipation	TC =25°C	60	W
$R_{θJc}$	Thermal Resistance Junction-to-Case (Note3)	2.1	°C/W	



20V/60A N-Channel Advanced Power MOSFET

Symbol	Parameter	Condition	Min.	Typ.	Max.	Unit
Static Electrical Characteristics @ T_J = 25°C (unless otherwise stated)						
V _{(BR)DSS}	Drain- Source Breakdown Voltage	VGS=0V ID=250μA	20	--	--	V
I _{DSS}	Zero Gate Voltage Drain current	VDS=20V, VGS=0V	--	--	1	μA
I _{GSS}	Gate-Body Leakage Current	VGS=±12V, VDS=0V	--	--	±100	nA
V _{GS(TH)}	Gate Threshold Voltage	VDS=VGS, ID=250μA	0.5	0.75	1	V
R _{DS(ON)}	Drain-Source On-State Resistance (Note4)	VGS=4.5V, ID=25A	--	2.8	4	mΩ
		VGS=2.5V, ID=20A	--	3.5	5	mΩ
Dynamic Electrical Characteristics @ T_J = 25°C (unless otherwise stated) (Note5)						
C _{iss}	Input Capacitance	VDS=10V, VGS=0V, F=1MHz	--	2000	--	pF
C _{oss}	Output Capacitance		--	500	--	pF
C _{rss}	Reverse Transfer Capacitance		--	200	--	pF
Q _g	Total Gate Charge	VDS=10V, ID=20A, VGS=10V	--	27	--	nC
Q _{gs}	Gate-Source Charge		--	6.5	--	nC
Q _{gd}	Gate-Drain Charge		--	6.4	--	nC
Switching Characteristics (Note5)						
t _{d(on)}	Turn-on Delay Time	VDD=10V, ID=2A, RL=1Ω VGS=4.5V, RG=3Ω	--	6.4	--	nS
t _r	Turn-on Rise Time		--	17.2	--	nS
t _{d(off)}	Turn-off Delay Time		--	29.6	--	nS
t _f	Turn-off Fall Time		--	16.8	--	nS
Source- Drain Diode Characteristics @ T_J = 25°C (unless otherwise stated)						
V _{SD}	Forward on voltage	IS=10A, VGS=0V	--	--	1.2	V

Note:

- Limited by T_{Jmax}, starting T_J = 25° C, R_G = 25Ω, V_D = 10V, V_{GS} = 10V. Part not recommended for use above this value.
- Repetitive Rating: Pulse width limited by maximum junction temperature.
- Surface Mounted on FR4 Board, t ≤ 10 sec.
- Pulse Test: pulse width ≤ 300 us, duty cycle ≤ 2%.
- Guaranteed by design, not subject to production testing.



20V/60A N-Channel Advanced Power MOSFET

Typical Characteristics

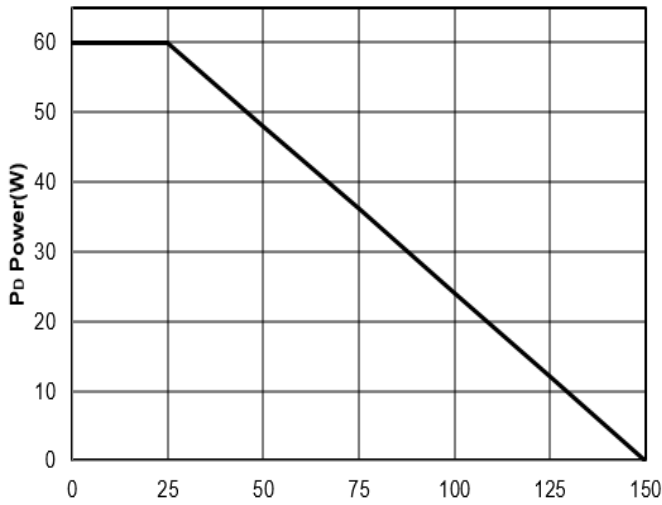

Figure1: T_J Junction Temperature (°C)

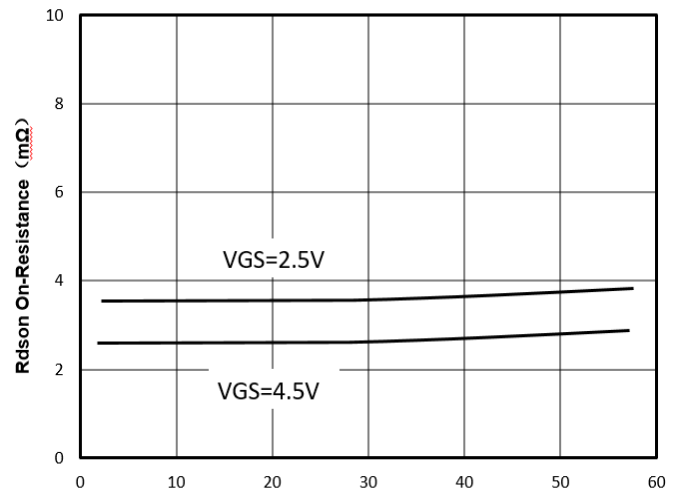

Figure2: I_D Drain Current (A)

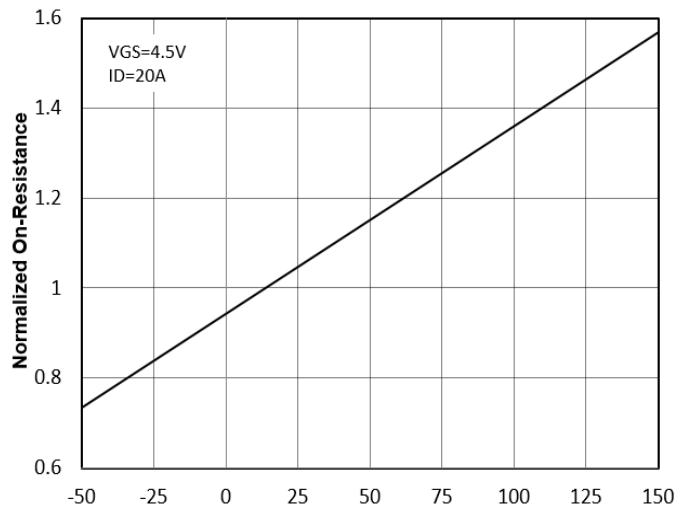

Figure3: T_J Junction Temperature (°C)

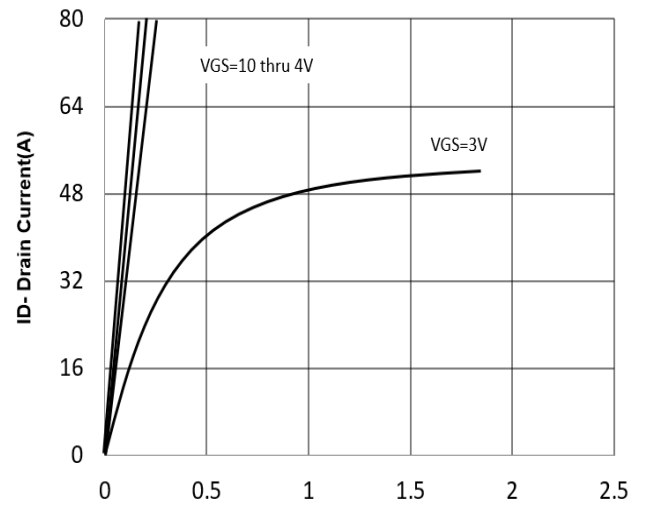

Figure4: V_{DS} Drain-Source Voltage (V)

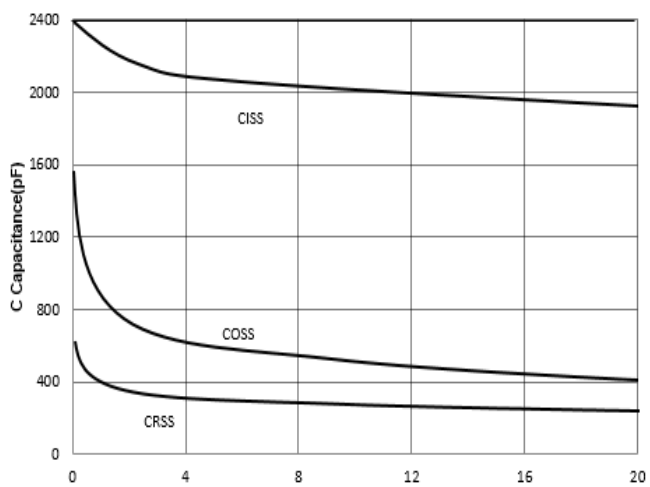

Figure5: V_{DS} Drain-Source Voltage (V)

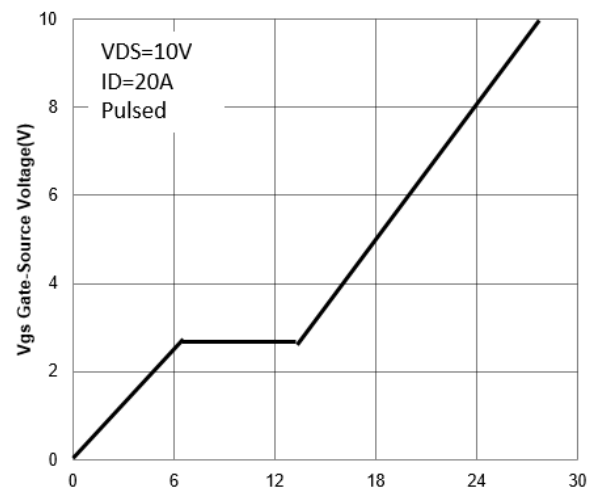

Figure6: Q_g Gate Charge (nC)



20V/60A N-Channel Advanced Power MOSFET

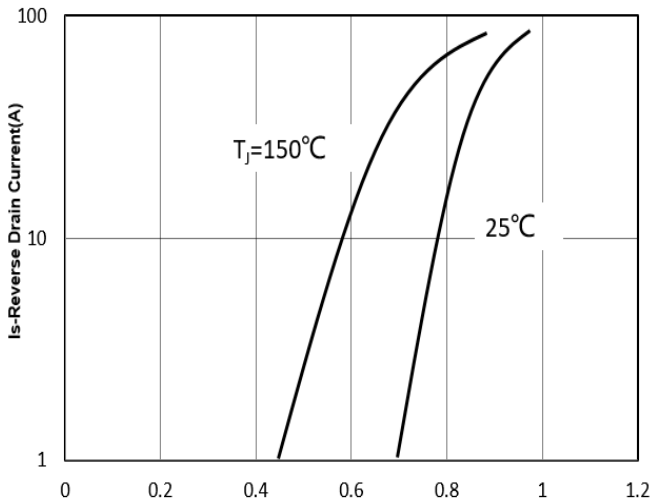

Figure7: Vsd Source-Drain Voltage (V)

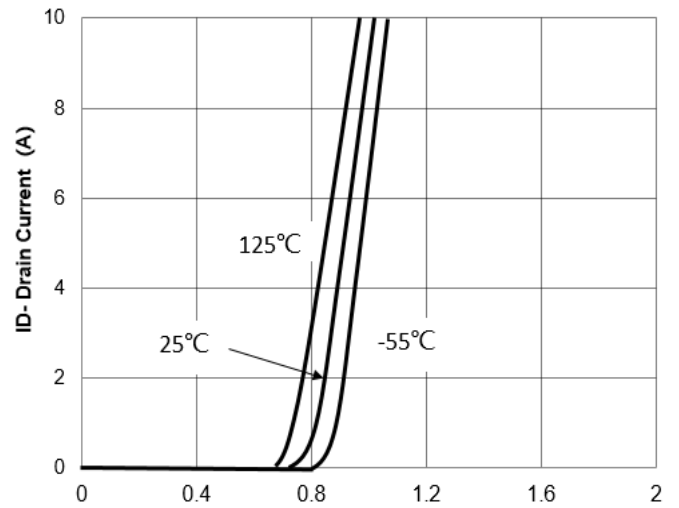

Figure8: Vgs Gate-Source Voltage (V)

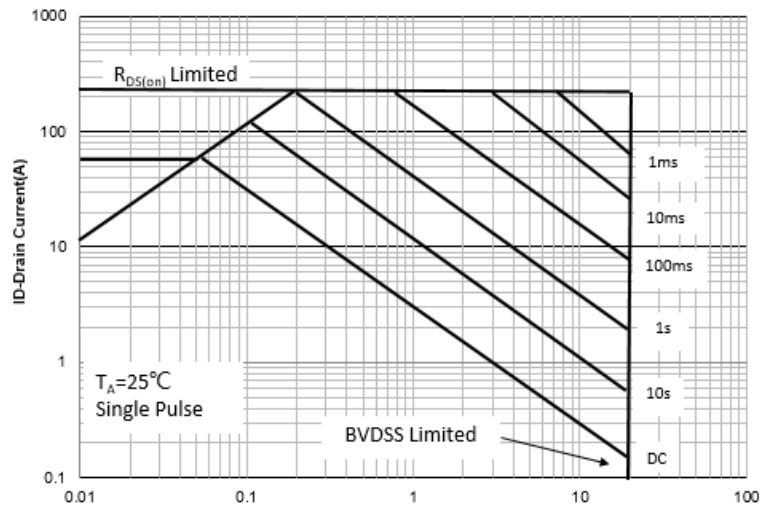

Figure9: Vds Drain -Source Voltage (V)

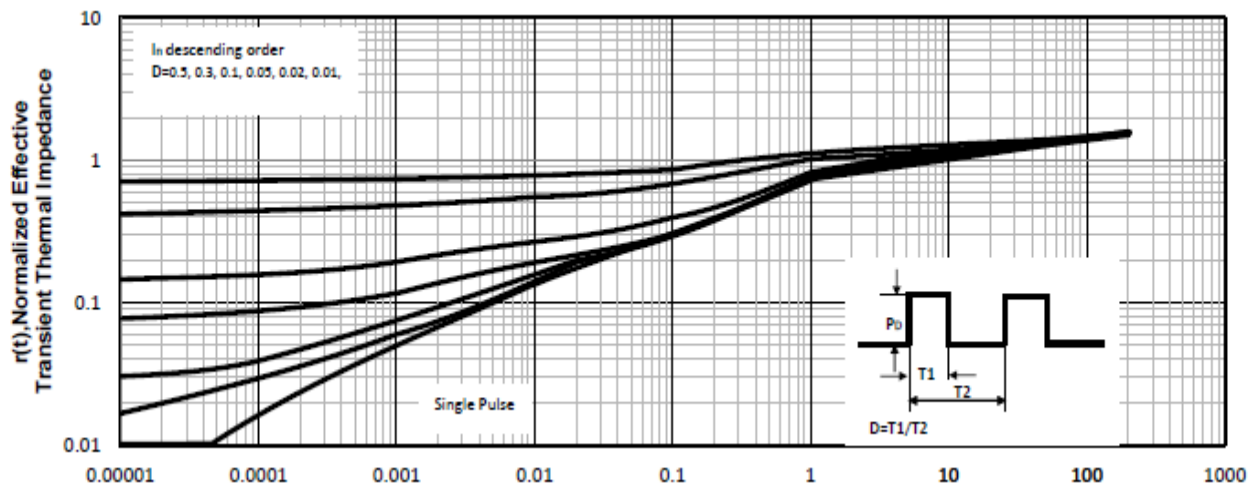
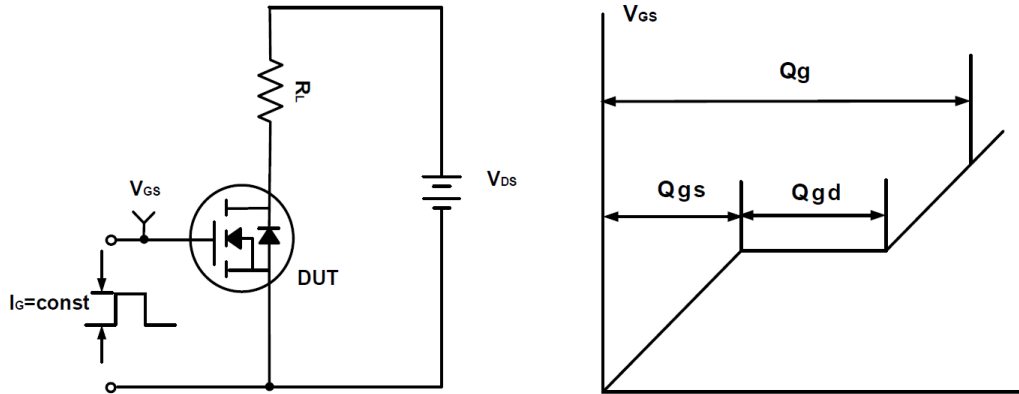
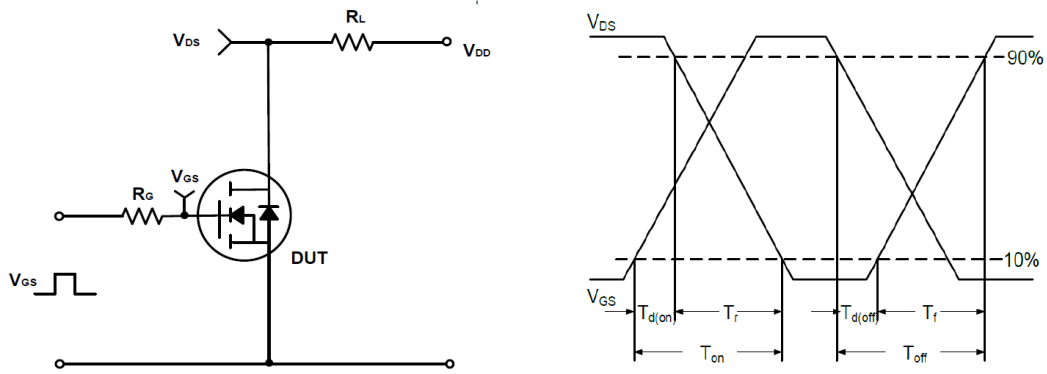
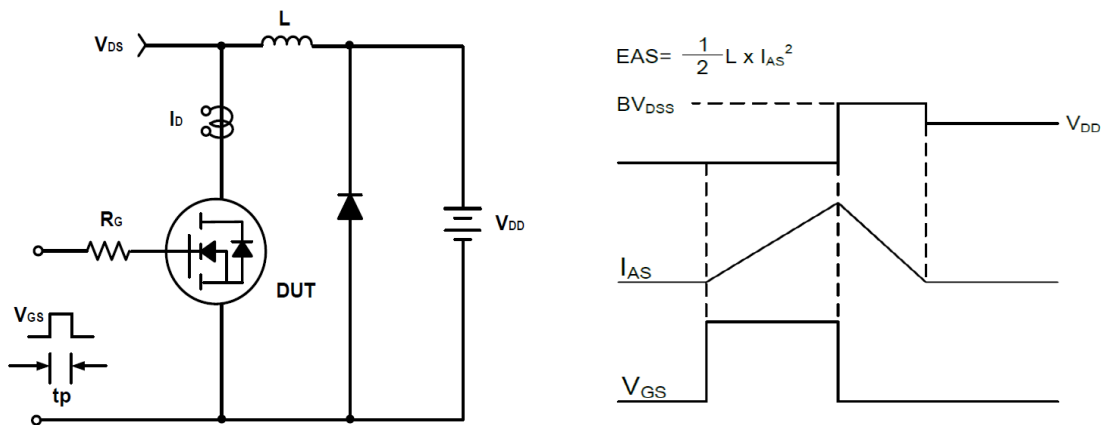

Figure10: Square Wave Pulse Duration (sec)

20V/60A N-Channel Advanced Power MOSFET
Test Circuit and Waveform:

Figure A Gate Charge Test Circuit & Waveforms

Figure B Switching Test Circuit & Waveforms

Figure C Unclamped Inductive Switching Circuit & Waveforms

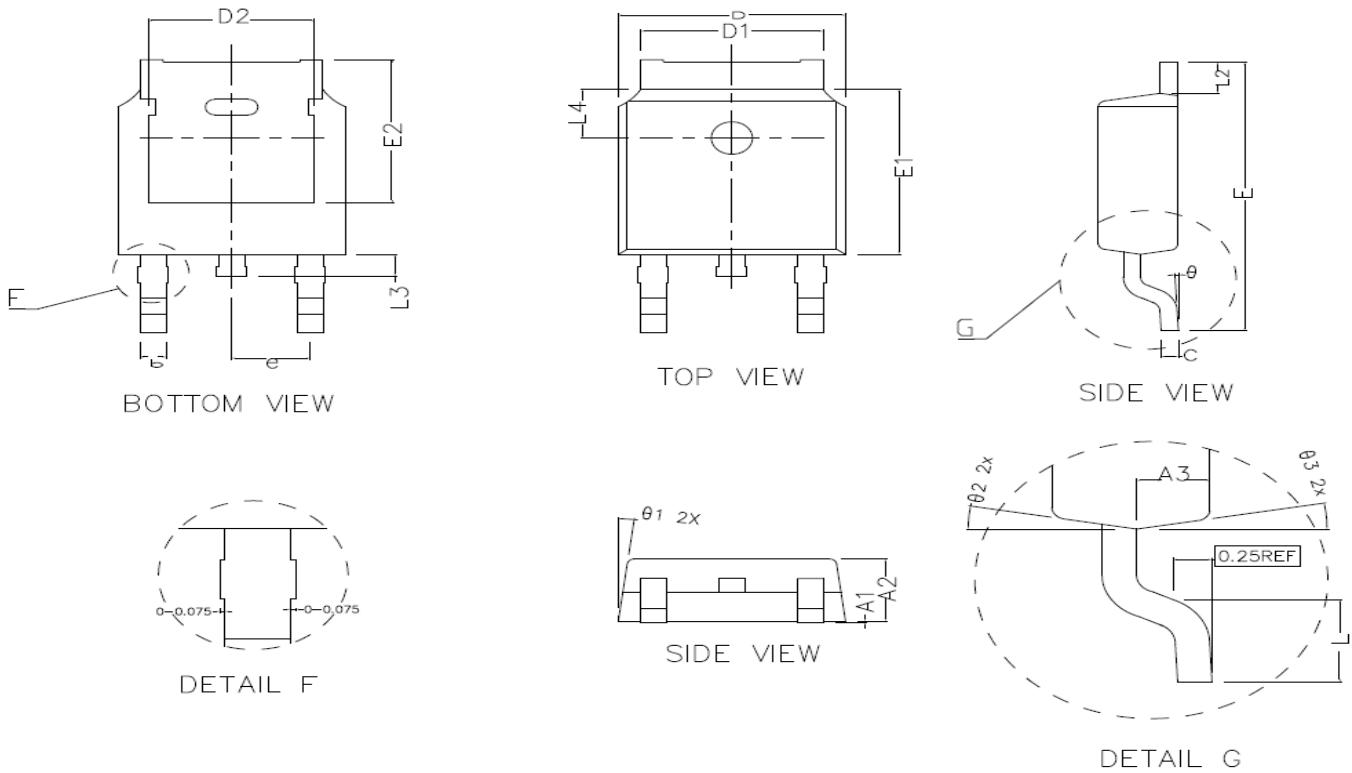

20V/60A N-Channel Advanced Power MOSFET

TO-252 Package Outline Dimensions (Units: mm)



COMMON DIMENSIONS (UNITS OF MEASURE IS mm)			
	MIN	NORMAL	MAX
A1	0.000	0.100	0.150
A2	2.200	2.300	2.400
A3	1.020	1.070	1.120
b	0.710	0.760	0.810
c	0.460	0.508	0.550
D	6.500	6.600	6.700
D1	5.330REF		
D2	4.830REF		
E	9.900	10.100	10.300
E1	6.000	6.100	6.200
E2	5.600REF		
e	2.286TYPE		
L	1.400	1.550	1.700
L2	1.10REF		
L3	0.80REF		
L4	1.80REF		
θ	0~8°		
θ_1	7° TYPE		
θ_2	10° TYPE		
θ_3	10° TYPE		