



60V/80A N-Channel Advanced Power MOSFET

Features

- Improved dv/dt Capability, High Ruggedness.
- Maximum Junction Temperature Range (150°C)
- 100% Avalanche Tested

BVDSS	60	V
ID	80	A
RDSON@VGS=10V	6.3	mΩ

Applications

- Power Supply
- DC-DC Converters
- Uninterruptible Power Supply (UPS)

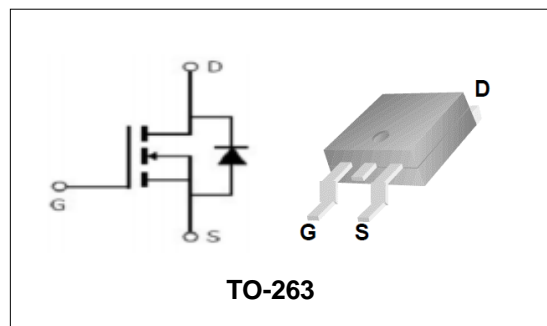

Order Information

Product	Package	Marking	Reel Size	Reel	Carton
PTY80N06	TO-263	PTY80N06	13inch	800PCS	6400PCS
			/	50PCS	5000PCS

Absolute Maximum Ratings

Symbol	Parameter	Rating	Unit	
Common Ratings (TC=25°C Unless Otherwise Noted)				
$V_{(BR)DSS}$	Drain-Source Breakdown Voltage	60	V	
V_{GS}	Gate-Source Voltage	±25	V	
T_J	Maximum Junction Temperature	150	°C	
T_{STG}	Storage Temperature Range	-55 to 150	°C	
I_S	Diode Continuous Forward Current	TC =25°C	100	A
Mounted on Large Heat Sink				
E_{AS}	Single Pulse Avalanche Energy (Note1)	242	mJ	
I_{DM}	Pulse Drain Current Tested (Silicon Limit) (Note2)	TC =25°C	320	A
I_D	Continuous Drain current	TC =25°C	80	A
P_D	Maximum Power Dissipation	TC =25°C	125	W
$R_{θJc}$	Thermal Resistance Junction-to-Case (Note3)	1	°C/W	
$R_{θJA}$	Thermal Resistance Junction-to-Ambient (Note3)	62.5	°C/W	

**60V/80A N-Channel Advanced Power MOSFET**

Symbol	Parameter	Condition	Min.	Typ.	Max.	Unit
Static Electrical Characteristics @ T_J = 25°C (unless otherwise stated)						
V _{(BR)DSS}	Drain- Source Breakdown Voltage	VGS=0V ID=250μA	60	--	--	V
I _{DSS}	Zero Gate Voltage Drain current	VDS=60V,VGS=0V	--	--	1	μA
I _{GSS}	Gate-Body Leakage Current	VGS=±25V,VDS=0V	--	--	±100	nA
V _{GS(TH)}	Gate Threshold Voltage	VDS=VGS,ID=250μA	2	3	4	V
R _{DS(ON)}	Drain-Source On-State Resistance (Note4)	VGS=10V, ID=40A	--	6.3	8	mΩ
Dynamic Electrical Characteristics @ T_J = 25°C (unless otherwise stated) (Note5)						
C _{iss}	Input Capacitance	VDS=25V,	--	3970	--	pF
C _{oss}	Output Capacitance	VGS=0V,	--	365	--	pF
C _{rss}	Reverse Transfer Capacitance	F=1MHz	--	257	--	pF
Q _g	Total Gate Charge	VDS=48V	--	91	--	nC
Q _{gs}	Gate-Source Charge	ID=40A	--	19	--	nC
Q _{gd}	Gate-Drain Charge	VGS=10V	--	30	--	nC
Switching Characteristics (Note5)						
t _{d(on)}	Turn-on Delay Time	VDD=34V,	--	57	--	nS
t _r	Turn-on Rise Time	ID=40A,	--	63	--	nS
t _{d(off)}	Turn-off Delay Time	VGS=10V	--	139	--	nS
t _f	Turn-off Fall Time		--	50	--	nS
Source- Drain Diode Characteristics @ T_J = 25°C (unless otherwise stated)						
V _{SD}	Forward on voltage	IS=40A,VGS=0V	--	--	1.3	V

Note:

- Limited by T_{Jmax}, starting T_J = 25° C, R_G = 25Ω, V_D =30V, VGS =10V. Part not recommended for use above this value.
- Repetitive Rating: Pulse width limited by maximum junction temperature.
- Surface Mounted on FR4 Board, t ≤ 10 sec.
- Pulse Test: pulse width ≤ 300 us, duty cycle ≤ 2%.
- Guaranteed by design, not subject to production testing.



60V/80A N-Channel Advanced Power MOSFET

Typical Characteristics

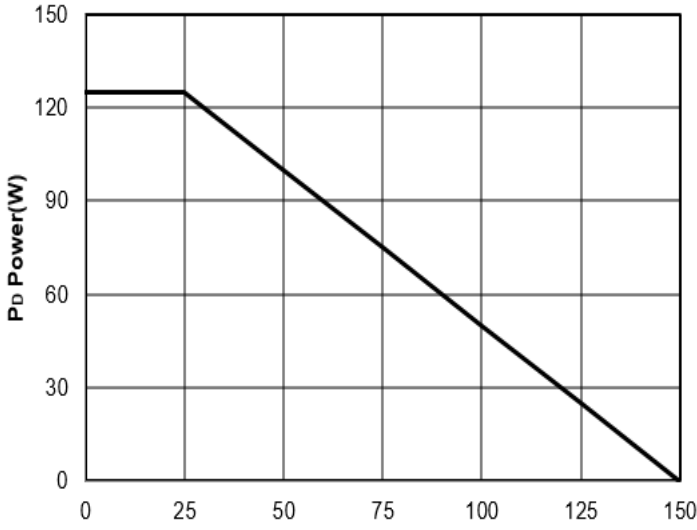

Figure1: T_j Junction Temperature (°C)

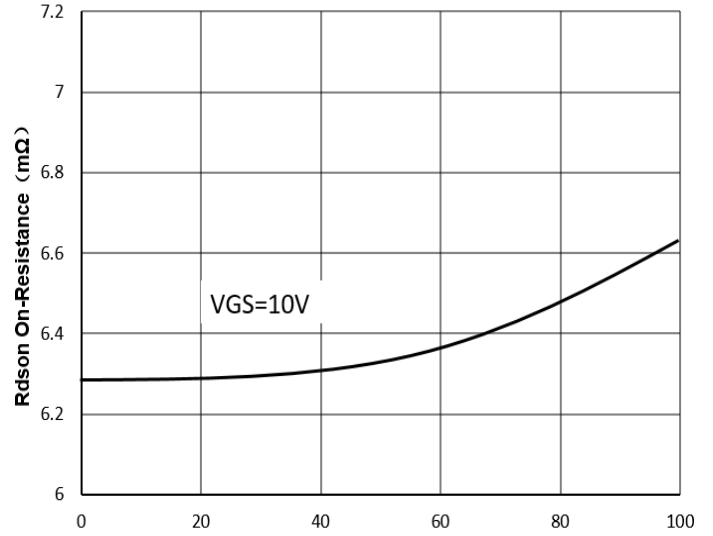

Figure2: I_d Drain Current (A)

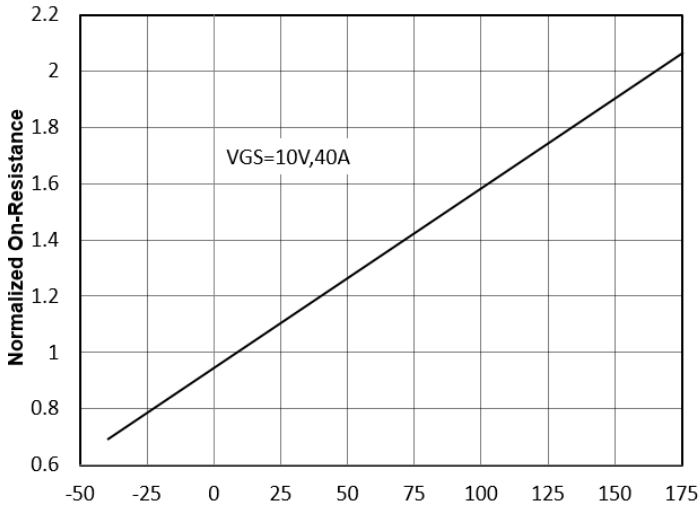

Figure3: T_j Junction Temperature (°C)

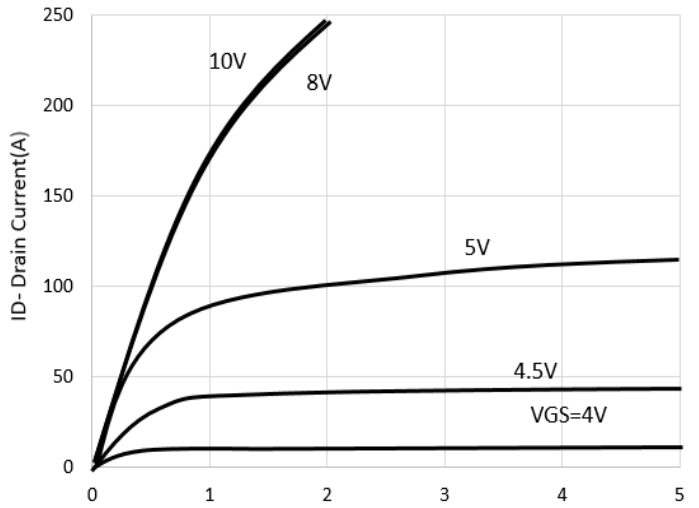

Figure4: V_{ds} Drain-Source Voltage (V)

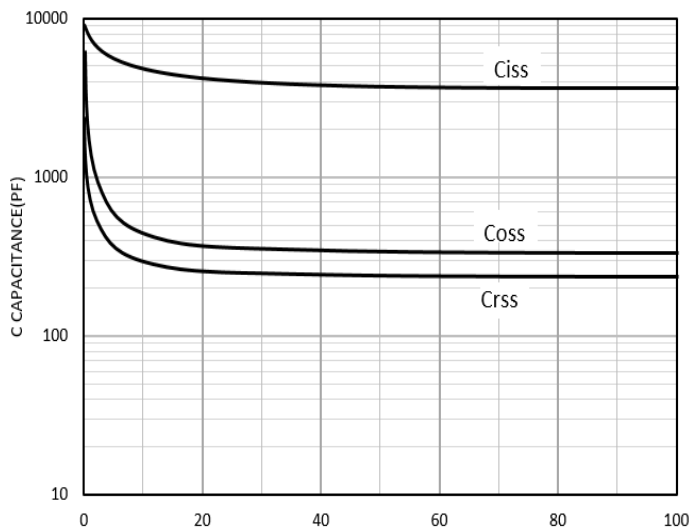

Figure5: V_{ds} Drain-Source Voltage (V)

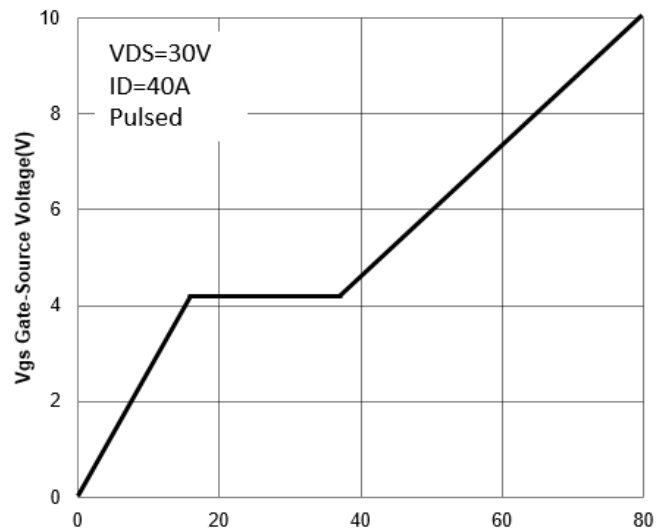

Figure6: Q_g Gate Charge (nC)



60V/80A N-Channel Advanced Power MOSFET

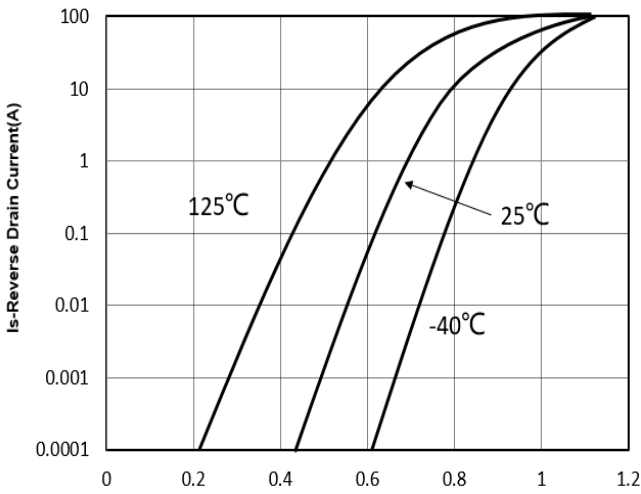

Figure7: Vsd Source-Drain Voltage (V)

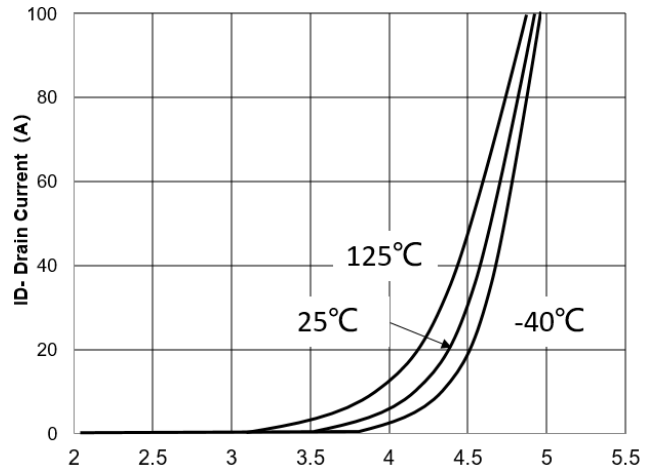

Figure8: Vgs Gate-Source Voltage (V)

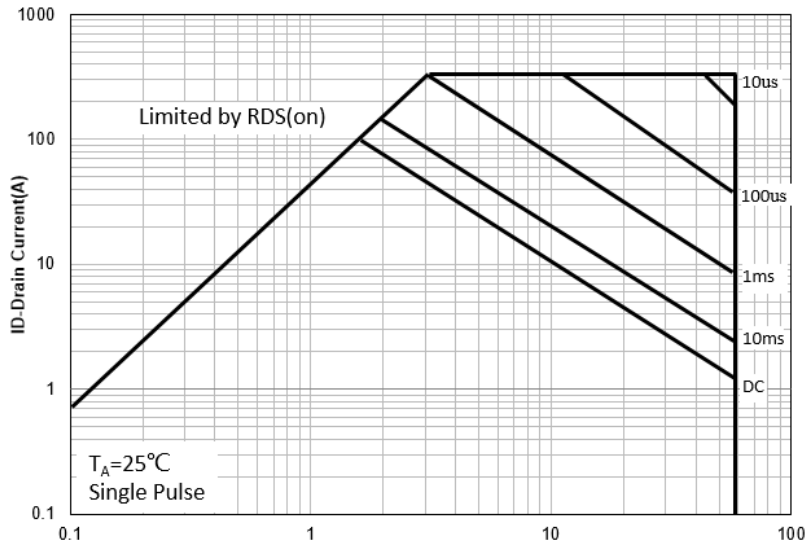

Figure9: VDS Drain -Source Voltage (V)

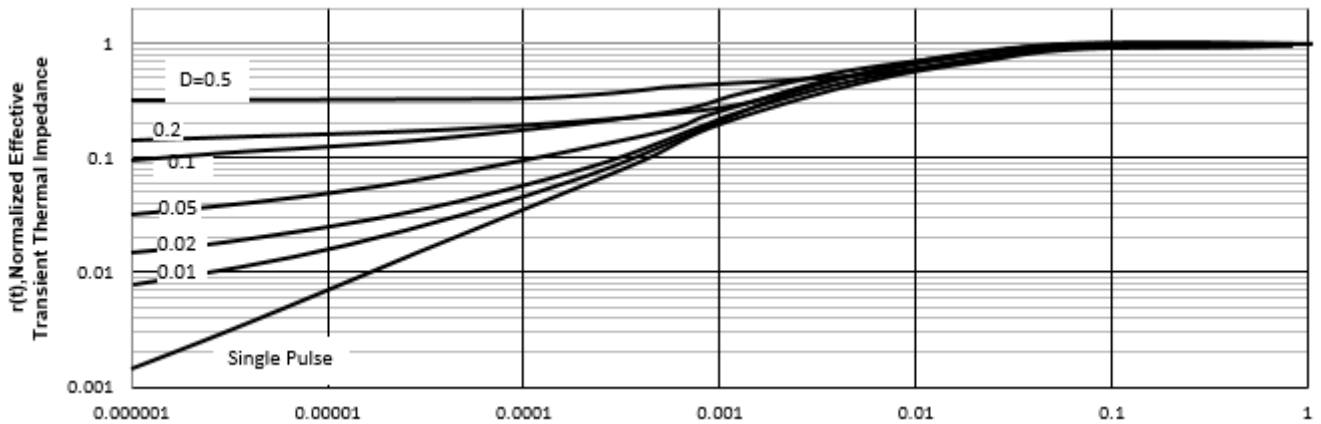
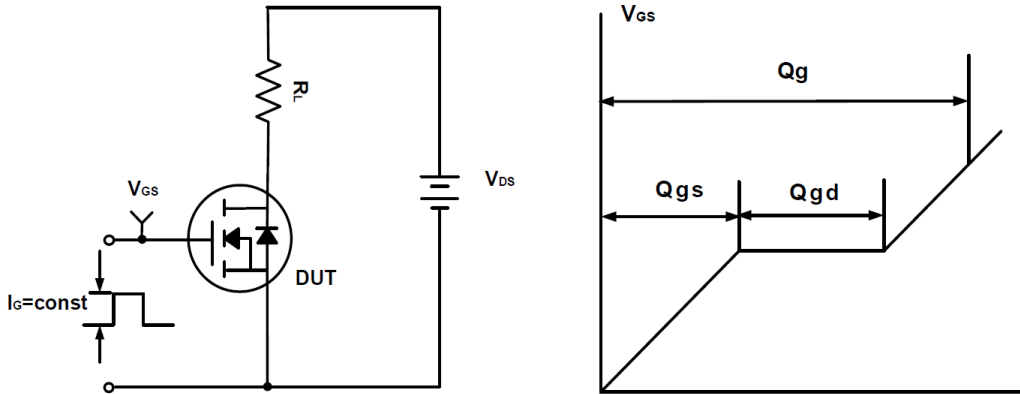
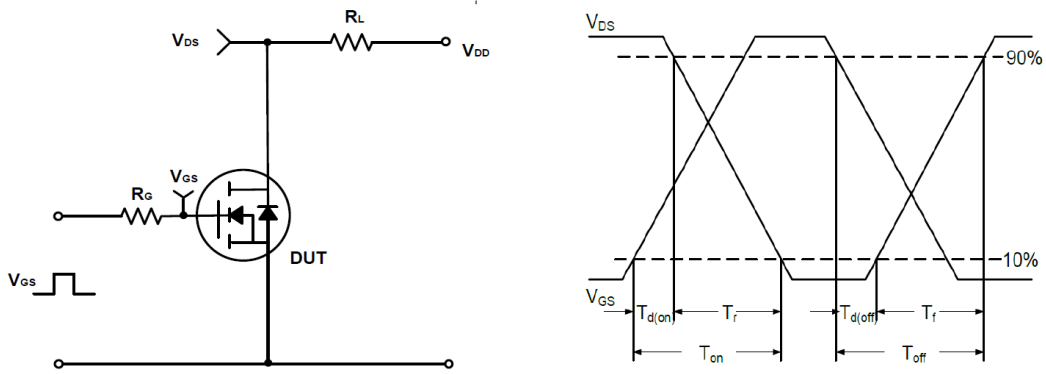
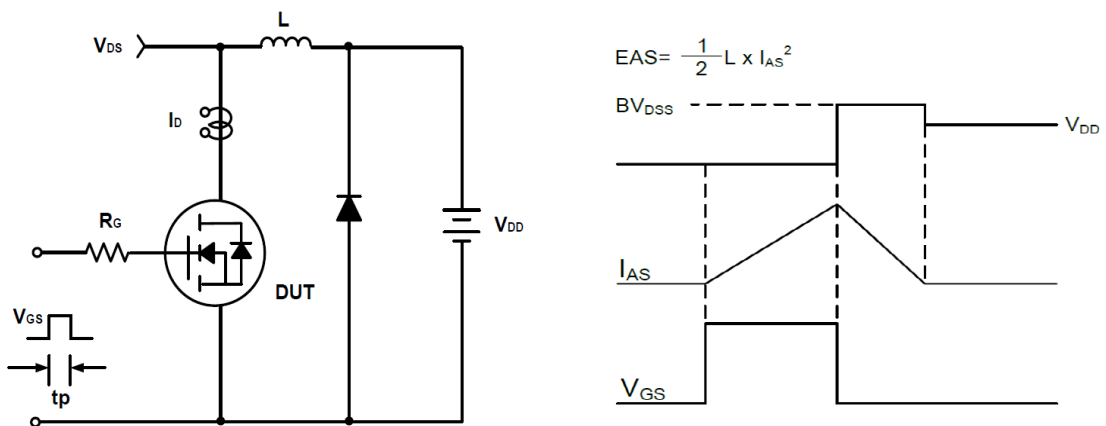
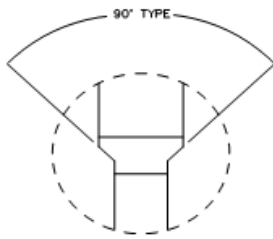

Figure10: Square Wave Pulse Duration (sec)

60V/80A N-Channel Advanced Power MOSFET
Test Circuit and Waveform:

Figure A Gate Charge Test Circuit & Waveforms

Figure B Switching Test Circuit & Waveforms

Figure C Unclamped Inductive Switching Circuit & Waveforms

60V/80A N-Channel Advanced Power MOSFET

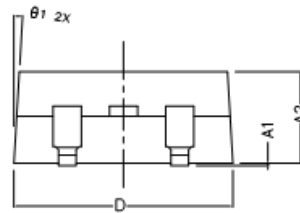
TO-263 Package Outline Dimensions (Units: mm)



DETAIL F



SIDE VIEW

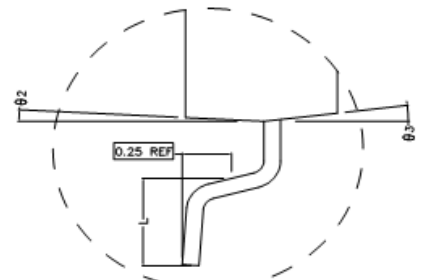

DETAIL G

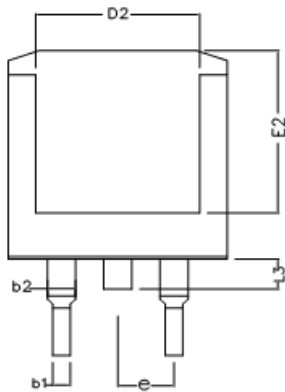

BOTTOM VIEW

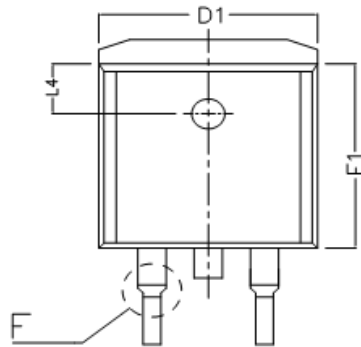

TOP VIEW

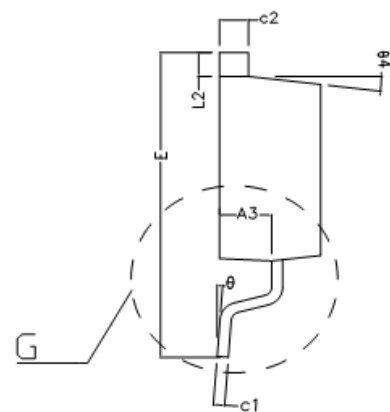

SIDE VIEW

COMMON DIMENSIONS (UNITS OF MEASURE IS mm)			
	MIN	NORMAL	MAX
A1	0.020	0.100	0.200
A2	4.470	4.570	4.670
A3	2.300	2.350	2.400
b1	0.750	0.800	0.850
b2	1.220	1.270	1.320
c1	0.450	0.500	0.550
c2	1.250	1.300	1.350
D	9.900	10.000	10.100
D1	9.880REF		
D2	7.400REF		
E	14.900	15.100	15.300
E1	9.000	9.100	9.200
E2	8.100REF		
e	2.540TYPE		
L	2.100	2.300	2.500
L2	1.100	1.200	1.300
L3	1.300	1.500	1.700
L4	2.50 TYPE		
θ ₁	3° TYPE		
θ ₂	3° TYPE		
θ ₃	7° TYPE		
θ ₄	7° TYPE		
θ	0 ~ 8°		