



## 20V/7A N-Channel Junction Power MOSFET

### Features

- High power and current handing capability
- Lead free product is acquired
- Surface mount package

BVDSS	20	V
ID	7	A
RDSON@VGS=4.5V	15	mΩ
RDSON@VGS=2.5V	20	mΩ

### Applications

- PWM application
- Load switch

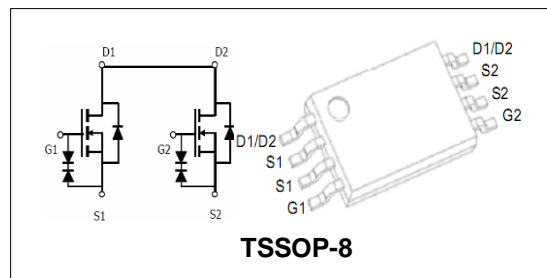

### Order Information

Product	Package	Marking	Reel Size	Reel	Carton
PT2010E	TSSOP-8	2010E	13inch	5000PCS	50000PCS

### Absolute Maximum Ratings

Symbol	Parameter	Rating	Unit
<b>Common Ratings (TC=25°C Unless Otherwise Noted)</b>			
$V_{(BR)DSS}$	Drain-Source Breakdown Voltage	20	V
$V_{GS}$	Gate-Source Voltage	±12	V
$T_J$	Maximum Junction Temperature	150	°C
$T_{STG}$	Storage Temperature Range	-55 to 150	°C
$I_S$	Diode Continuous Forward Current	$T_A = 25^\circ C$ 7	A
<b>Mounted on Large Heat Sink</b>			
$I_{DM}$	Pulse Drain Current Tested (Silicon Limit) (Note1)	$T_A = 25^\circ C$ 30	A
$I_D$	Continuous Drain current	$T_A = 25^\circ C$ 7	A
$P_D$	Maximum Power Dissipation	$T_A = 25^\circ C$ 1.5	W
$R_{\theta Ja}$	Thermal Resistance Junction-to-Ambient (Note2)	83.3	°C/W



## 20V/7A N-Channel Junction Power MOSFET

Symbol	Parameter	Condition	Min.	Typ.	Max.	Unit
<b>Static Electrical Characteristics @ T<sub>J</sub> = 25°C (unless otherwise stated)</b>						
V <sub>(BR)DSS</sub>	Drain- Source Breakdown Voltage	VGS=0V ID=250μA	20	21.5	23	V
I <sub>DSS</sub>	Zero Gate Voltage Drain current	VDS=20V,VGS=0V	--	--	1	μA
I <sub>GSS</sub>	Gate-Body Leakage Current	VGS=±10V,VDS=0V	--	--	±10	μA
V <sub>GS(TH)</sub>	Gate Threshold Voltage	VDS=VGS,ID=250μA	0.45	0.7	1.0	V
R <sub>DS(ON)</sub>	Drain-Source On-State Resistance (Note3)	VGS=4.5V, ID=6.5A	--	15	21	mΩ
		VGS=2.5V, ID=5.5A	--	20	27	
<b>Dynamic Electrical Characteristics @ T<sub>J</sub> = 25°C (unless otherwise stated) (Note4)</b>						
C <sub>iss</sub>	Input Capacitance	VDS=10V, VGS=0V, F=1MHz	--	1150	--	pF
C <sub>oss</sub>	Output Capacitance		--	185	--	pF
C <sub>rss</sub>	Reverse Transfer Capacitance		--	145	--	pF
Q <sub>g</sub>	Total Gate Charge	VDS=10V, ID=7A, VGS=4.5V	--	15	--	nC
Q <sub>gs</sub>	Gate-Source Charge		--	0.8	--	nC
Q <sub>gd</sub>	Gate-Drain Charge		--	3.2	--	nC
<b>Switching Characteristics (Note4)</b>						
t <sub>d(on)</sub>	Turn-on Delay Time	VDD=10V, RL=1.35Ω, VGS=5V RG=3Ω	--	6	--	nS
t <sub>r</sub>	Turn-on Rise Time		--	13	--	nS
t <sub>d(off)</sub>	Turn-off Delay Time		--	52	--	nS
t <sub>f</sub>	Turn-off Fall Time		--	16	--	nS
<b>Source- Drain Diode Characteristics @ T<sub>J</sub> = 25°C (unless otherwise stated)</b>						
V <sub>SD</sub>	Forward on voltage	IS=1A,VGS=0V	--	--	1.2	V

Note:

1. Repetitive Rating: Pulse width limited by maximum junction temperature.
2. Surface Mounted on FR4 Board, t ≤ 10 sec.
3. Pulse Test: pulse width ≤ 300 us, duty cycle ≤ 2%.
4. Guranteed by design, not subject to production testing.



20V/7A N-Channel Junction Power MOSFET

Typical Characteristics

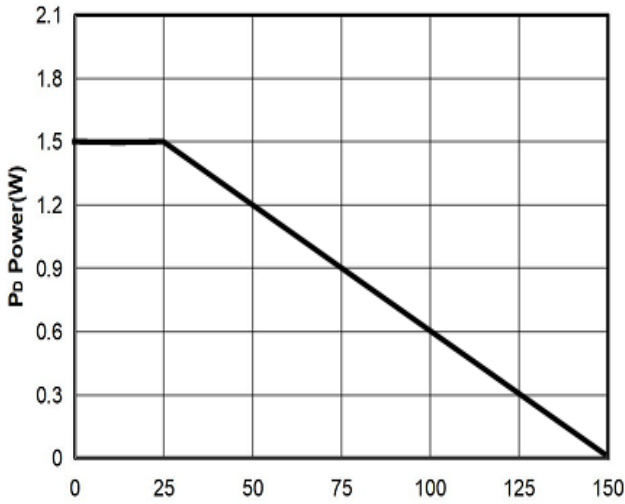

Figure1: T<sub>j</sub> Junction Temperature (°C)

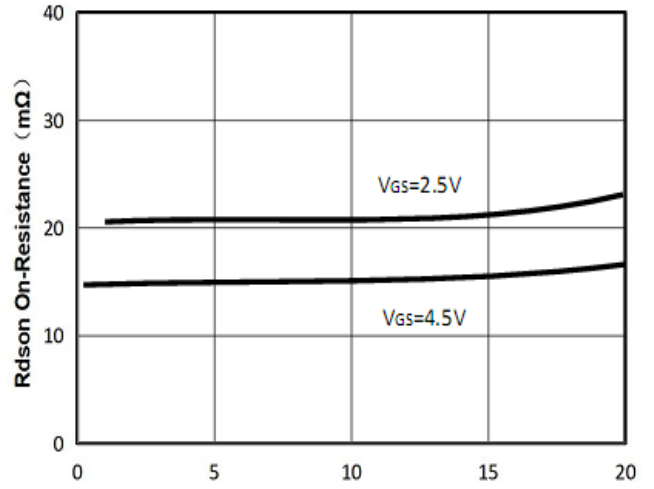

Figure2: I<sub>d</sub> Drain Current (A)

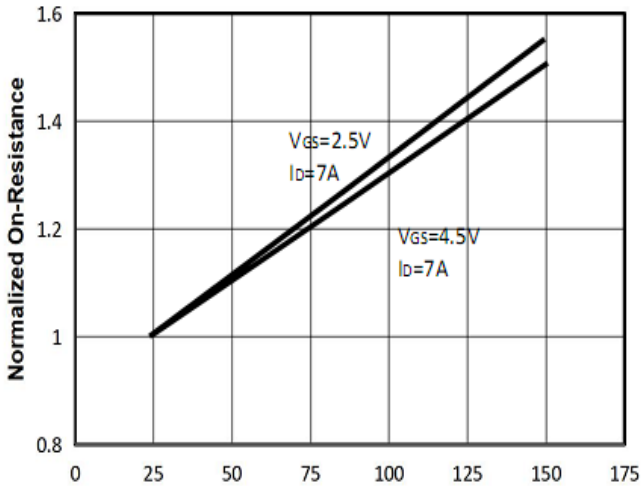

Figure3: T<sub>j</sub> Junction Temperature (°C)

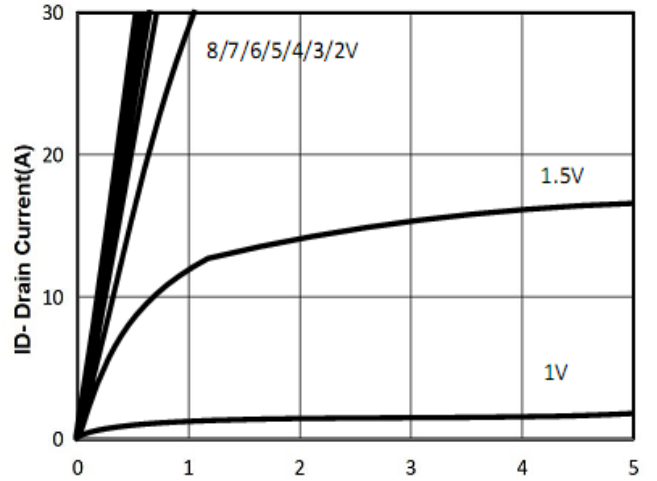

Figure4: V<sub>ds</sub> Drain-Source Voltage (V)

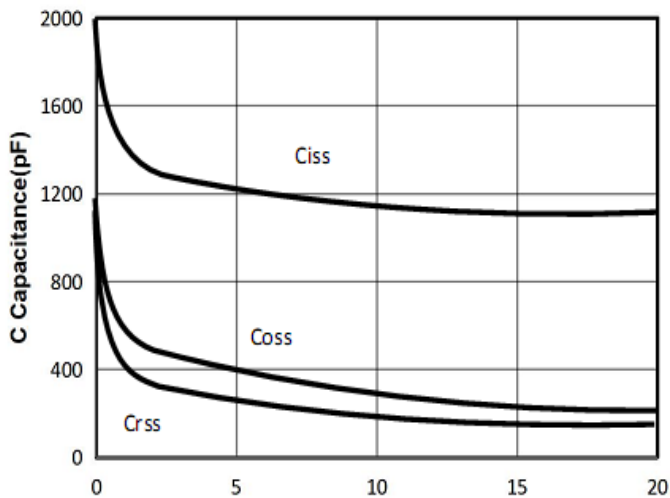

Figure5: V<sub>ds</sub> Draun-Source Voltage (V)

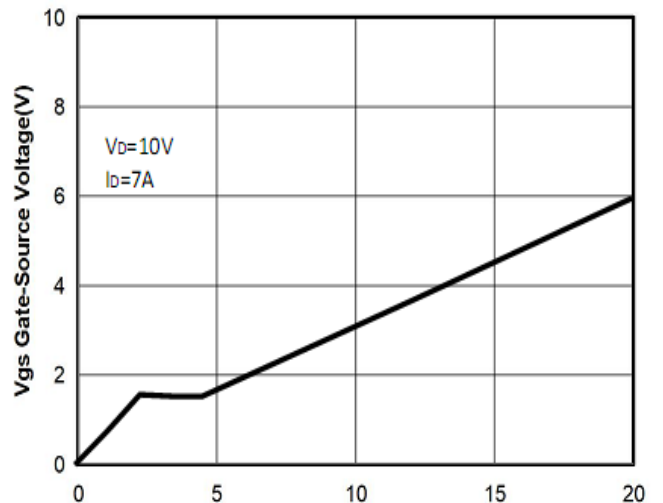

Figure6: Q<sub>g</sub> Gate Charge (nC)



20V/7A N-Channel Junction Power MOSFET

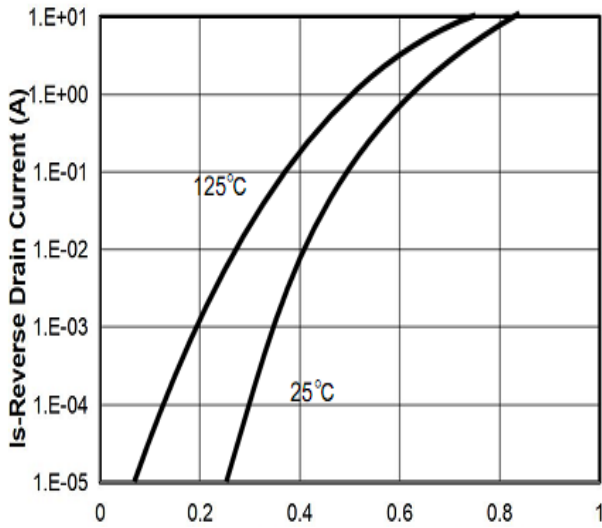

Figure7: Vsd Source-Drain Voltage (V)

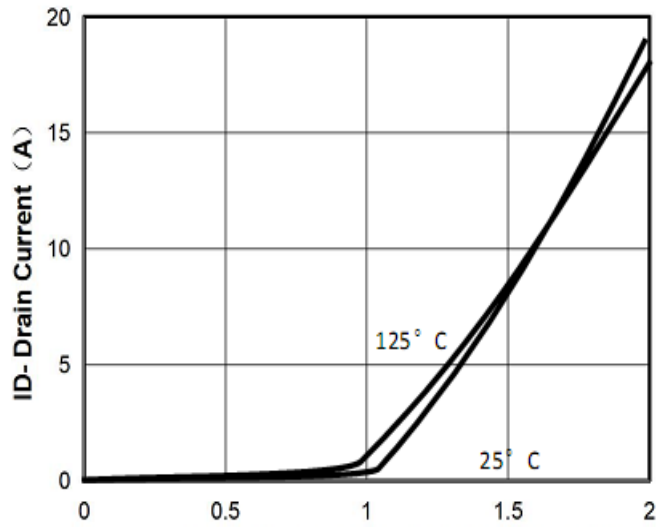

Figure8: Vgs Gate-Source Voltage (V)

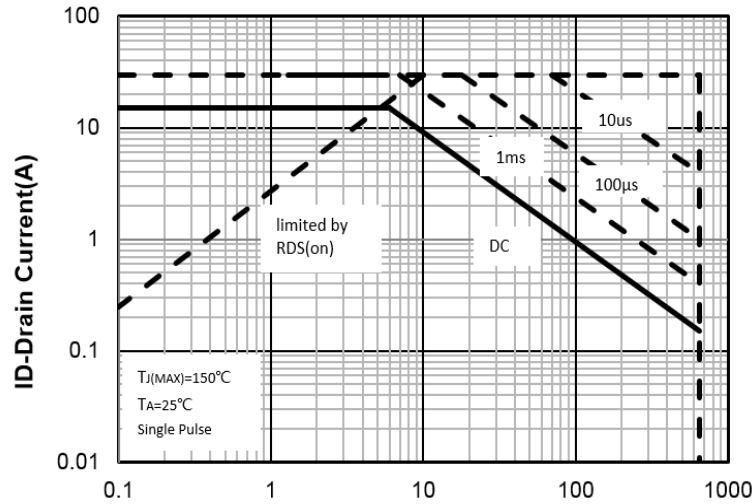

Figure9: VDS Drain-Source Voltage (V)

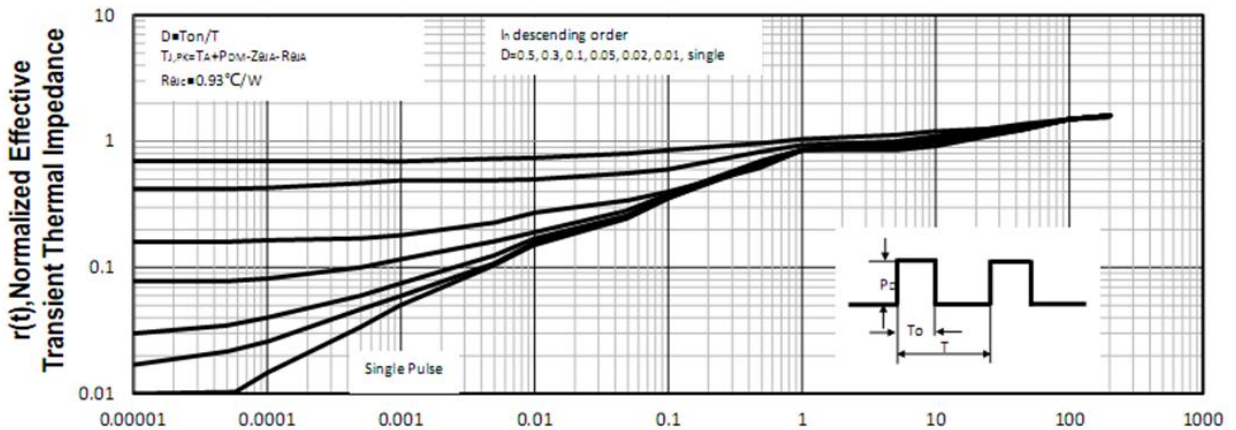

Figure10: Square Wave Pulse Duration (sec)

20V/7A N-Channel Junction Power MOSFET

Test Circuit and Waveform:

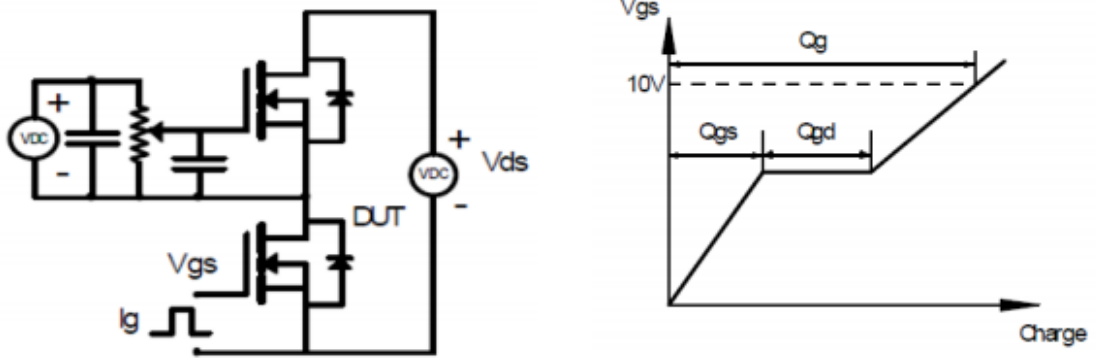

Figure A Gate Charge Test Circuit & Waveforms

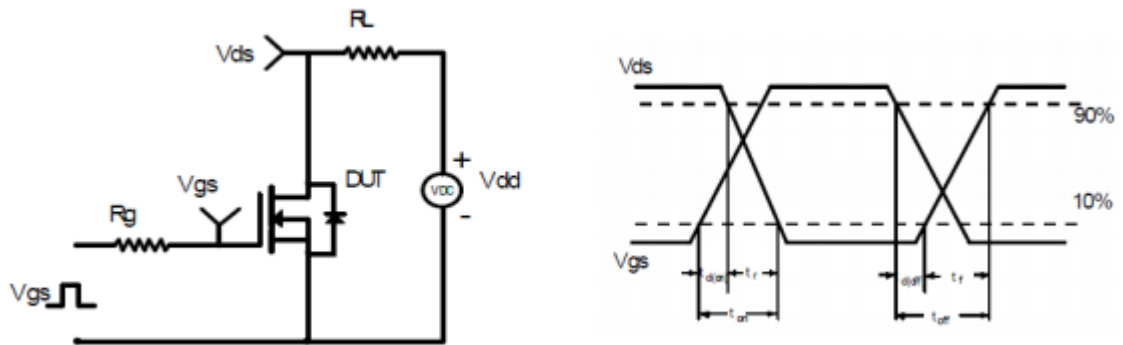

Figure B Switching Test Circuit & Waveforms

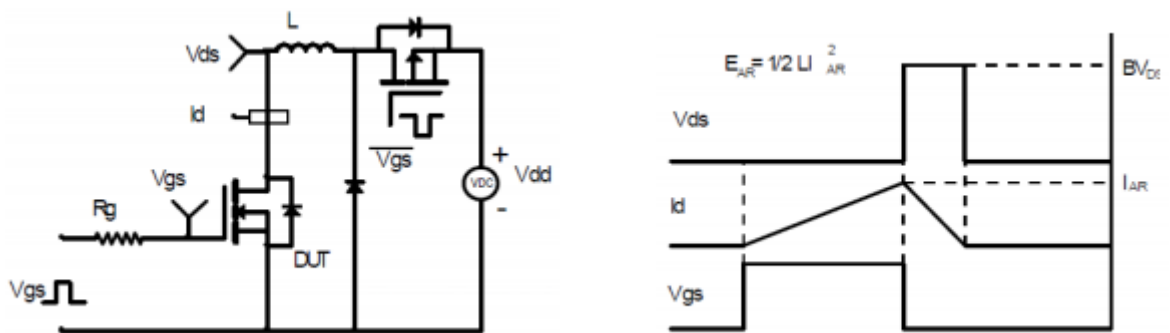
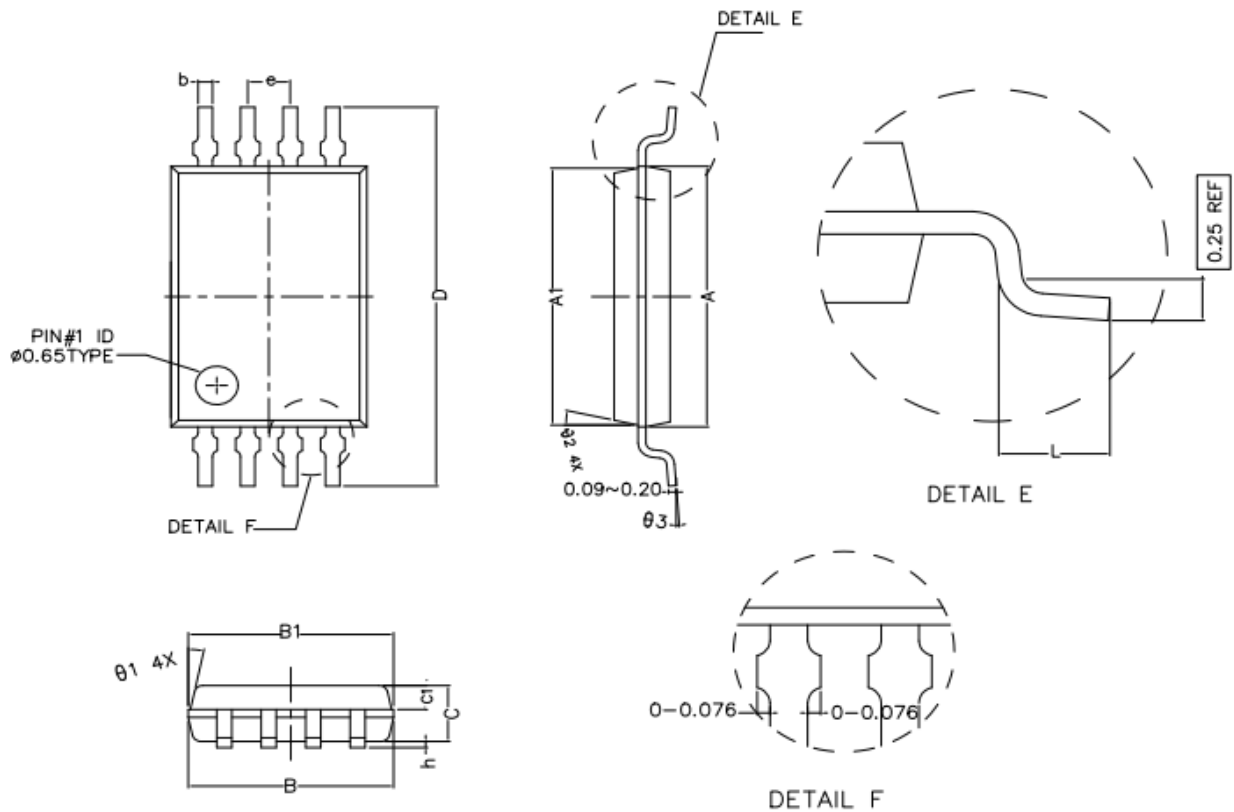

Figure C Unclamped Inductive Switching Circuit & Waveforms



20V/7A N-Channel Junction Power MOSFET

TSSOP-8 Package Outline Dimensions (Units: mm)



COMMON DIMENSIONS (UNITS OF MEASURE IS mm)			
	MIN	NORMAL	MAX
A	4.300	4.400	4.500
A1	4.240	4.340	4.440
B	2.900	3.000	3.100
B1	2.840	2.940	3.040
C	0.850	0.900	0.950
C1	0.337	0.387	0.437
D	6.250	6.400	6.550
L	0.450	0.600	0.750
b	0.170	0.220	0.300
h	0.050	0.100	0.150
e	0.650TYPE		
$\theta_1$	12° TYPE		
$\theta_2$	12° TYPE		
$\theta_3$	0° ~ 7°		