



## 500V/5A N-Channel Junction Power MOSFET

### Features

- New technology for high voltage device.
- Low on-resistance and low conduction losses
- Small package
- Ultra Low Gate Charge cause lower driving requirements
- 100% Avalanche Tested

BVDSS	500	V
ID	5	A
RDSON@VGS=10V	1.5	Ω

### Applications

- Power factor correction (PFC)
- Switched mode power supplies(SMPS)
- Uninterruptible Power Supply (UPS)

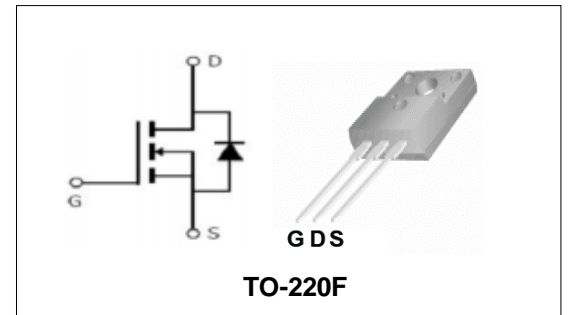

### Order Information

Product	Package	Marking	Tube	Carton
PTF5N50	TO-220F	PTF5N50	50PCS	5000PCS

### Absolute Maximum Ratings

Symbol	Parameter	Rating	Unit	
<b>Common Ratings (TC=25°C Unless Otherwise Noted)</b>				
$V_{(BR)DSS}$	Drain-Source Breakdown Voltage	500	V	
$V_{GS}$	Gate-Source Voltage	±30	V	
$T_J$	Maximum Junction Temperature	150	°C	
$T_{STG}$	Storage Temperature Range	-55 to 150	°C	
$I_S$	Diode Continuous Forward Current	TC =25°C	5	A
<b>Mounted on Large Heat Sink</b>				
$E_{AS}$	Single Pulse Avalanche Energy (Note1)	131	mJ	
$I_{DM}$	Pulse Drain Current Tested (Silicon Limit) (Note2)	TC =25°C	20	A
$I_D$	Continuous Drain current	TC =25°C	5	A
$P_D$	Maximum Power Dissipation	TC =25°C	39	W
$R_{θJc}$	Thermal Resistance Junction-to-Case (Note3)	3.2	°C/W	

**500V/5A N-Channel Junction Power MOSFET**

Symbol	Parameter	Condition	Min.	Typ.	Max.	Unit
<b>Static Electrical Characteristics @ T<sub>J</sub> = 25°C (unless otherwise stated)</b>						
V <sub>(BR)DSS</sub>	Drain- Source Breakdown Voltage	VGS=0V ID=250μA	500	--	--	V
I <sub>DSS</sub>	Zero Gate Voltage Drain current	VDS=500V,VGS=0V	--	--	1	μA
I <sub>GSS</sub>	Gate-Body Leakage Current	VGS=±30V,VDS=0V	--	--	±100	nA
V <sub>GS(TH)</sub>	Gate Threshold Voltage	VDS=VGS,ID=250μA	2	3	4	V
R <sub>DS(ON)</sub>	Drain-Source On-State Resistance (Note4)	VGS=10V, ID=2.5A	--	1.5	1.7	Ω
<b>Dynamic Electrical Characteristics @ T<sub>J</sub> = 25°C (unless otherwise stated) (Note5)</b>						
C <sub>iss</sub>	Input Capacitance	VDS=25V, VGS=0V, F=1MHz	--	478	--	pF
C <sub>oss</sub>	Output Capacitance		--	54	--	pF
C <sub>rss</sub>	Reverse Transfer Capacitance		--	15	--	pF
Q <sub>g</sub>	Total Gate Charge	VDS=400V, ID=5A, VGS=10V	--	13.7	--	nC
Q <sub>gs</sub>	Gate-Source Charge		--	3.4	--	nC
Q <sub>gd</sub>	Gate-Drain Charge		--	5.8	--	nC
<b>Switching Characteristics (Note5)</b>						
t <sub>d(on)</sub>	Turn-on Delay Time	VDD=250V, ID=5A, VGS=10V RG=25Ω	--	46	--	nS
t <sub>r</sub>	Turn-on Rise Time		--	26	--	nS
t <sub>d(off)</sub>	Turn-off Delay Time		--	130	--	nS
t <sub>f</sub>	Turn-off Fall Time		--	210	--	nS
<b>Source- Drain Diode Characteristics @ T<sub>J</sub> = 25°C (unless otherwise stated)</b>						
V <sub>SD</sub>	Forward on voltage	IS=5A,VGS=0V	--	--	1.4	V

Note:

- Limited by T<sub>Jmax</sub>, starting T<sub>J</sub> = 25° C, R<sub>G</sub> = 25Ω, V<sub>D</sub> =50V, V<sub>G</sub>S =10V. Part not recommended for use above this value.
- Repetitive Rating: Pulse width limited by maximum junction temperature.
- Surface Mounted on FR4 Board, t ≤ 10 sec.
- Pulse Test: pulse width ≤ 300 us, duty cycle ≤ 2%.
- Guaranteed by design, not subject to production testing.



500V/5A N-Channel Junction Power MOSFET  
Typical Characteristics

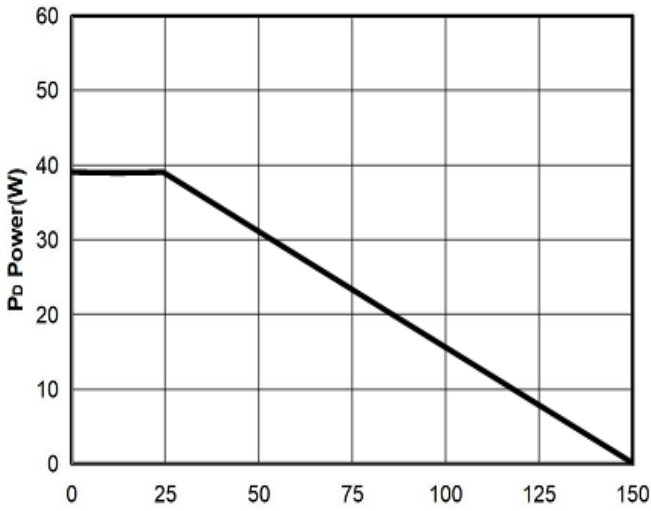

Figure1: Tj Junction Temperature (°C)

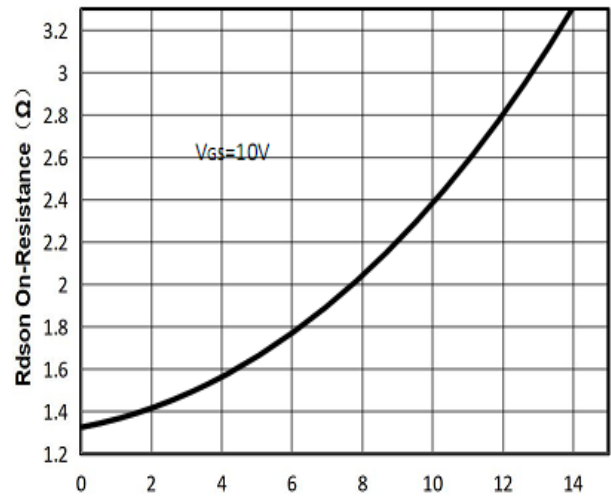

Figure2: Id Drain Current (A)

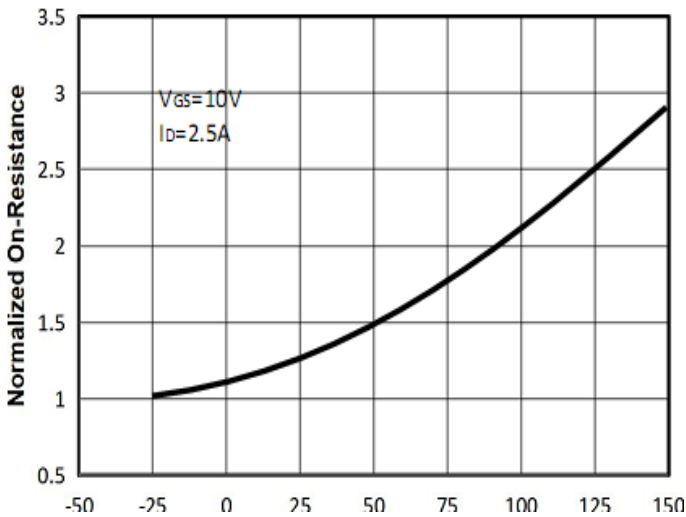

Figure3: Tj Junction Temperature (°C)

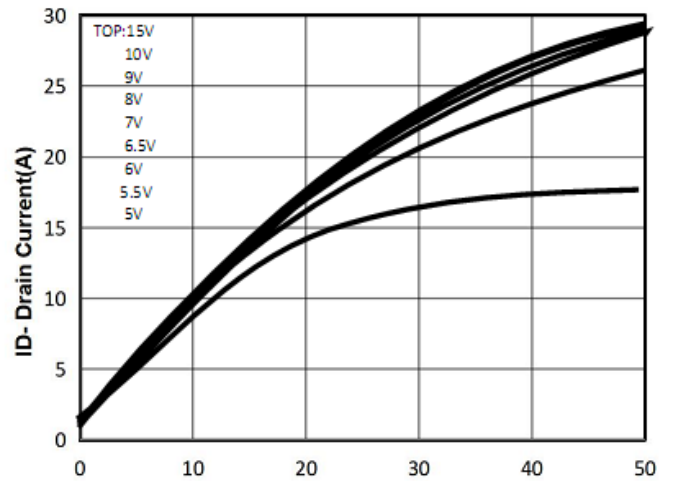

Figure4: Vds Drain-Source Voltage (V)

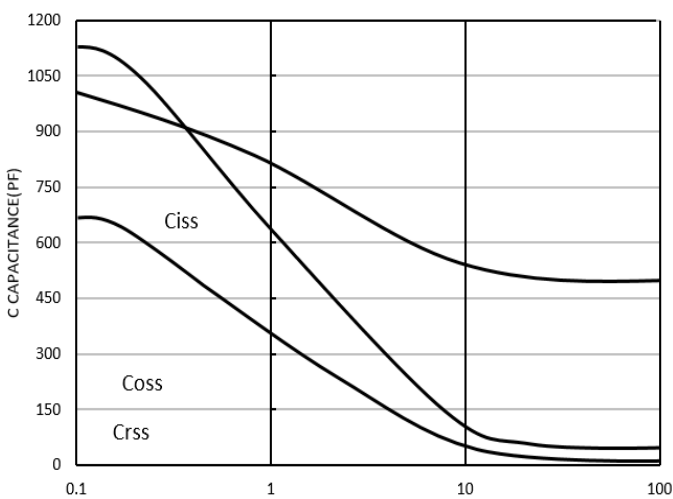

Figure5: Vds Drain-Source Voltage (V)

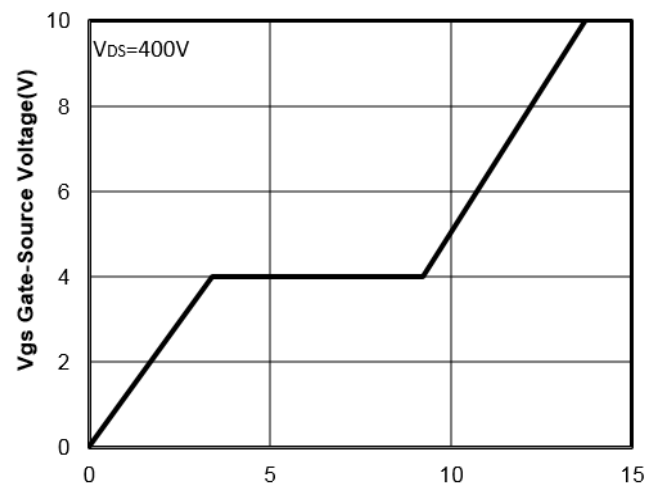

Figure6: Qg Gate Charge (nC)



500V/5A N-Channel Junction Power MOSFET

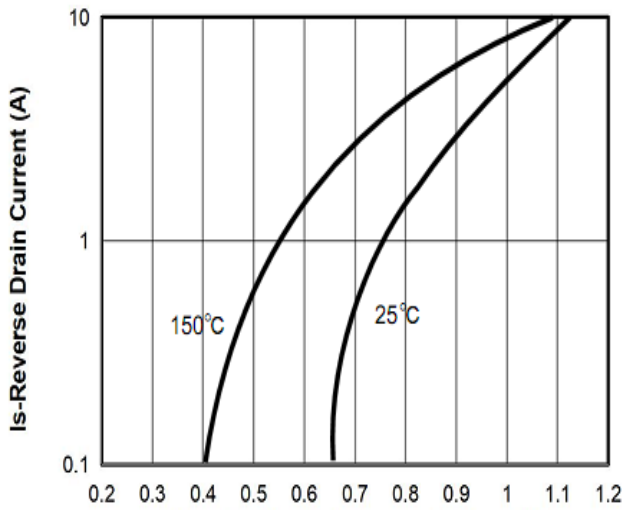

Figure7: Vsd Source-Drain Voltage (V)

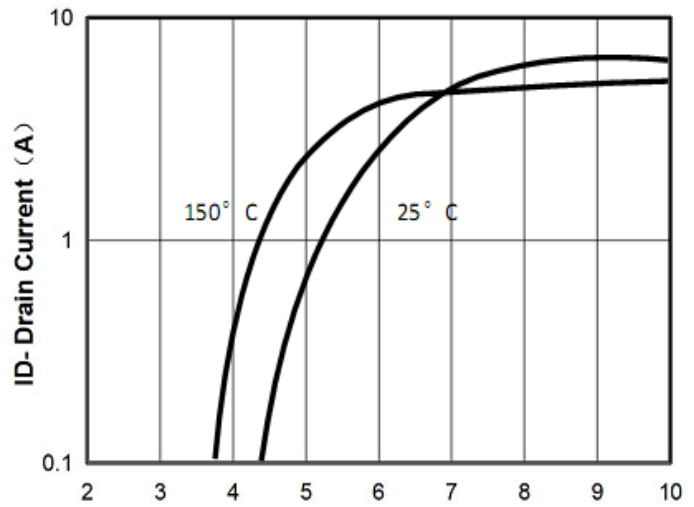

Figure8: Vgs Gate-Source Voltage (V)

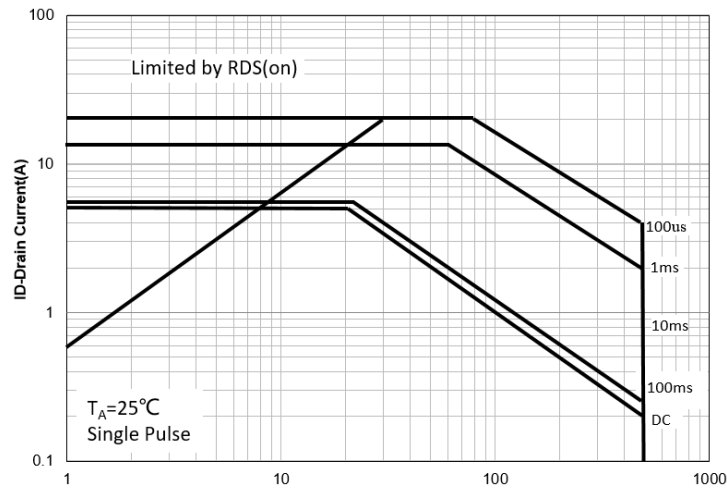

Figure9: VDS Drain-Source Voltage (V)

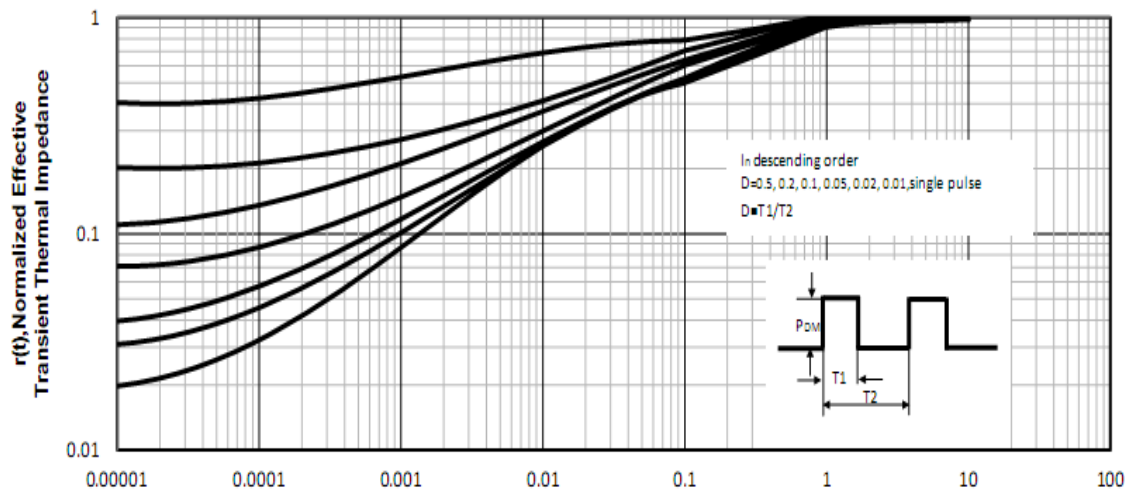

Figure10: Square Wave Pulse Duration (sec)

## 500V/5A N-Channel Junction Power MOSFET

### Test Circuit and Waveform:

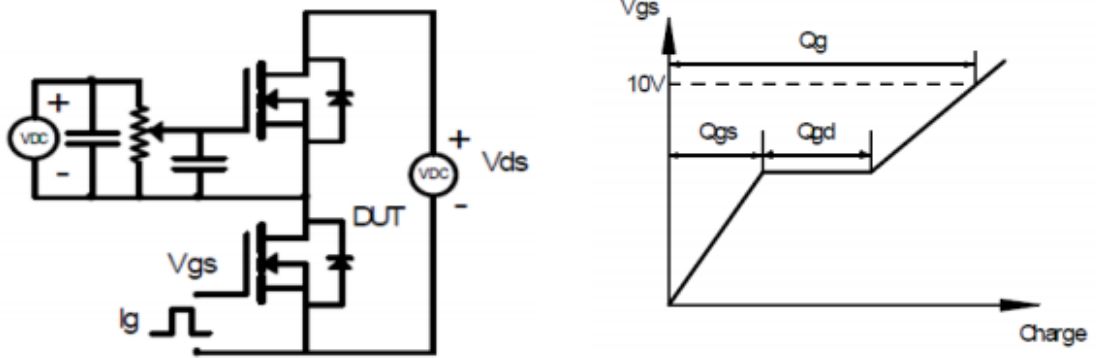

Figure A Gate Charge Test Circuit & Waveforms

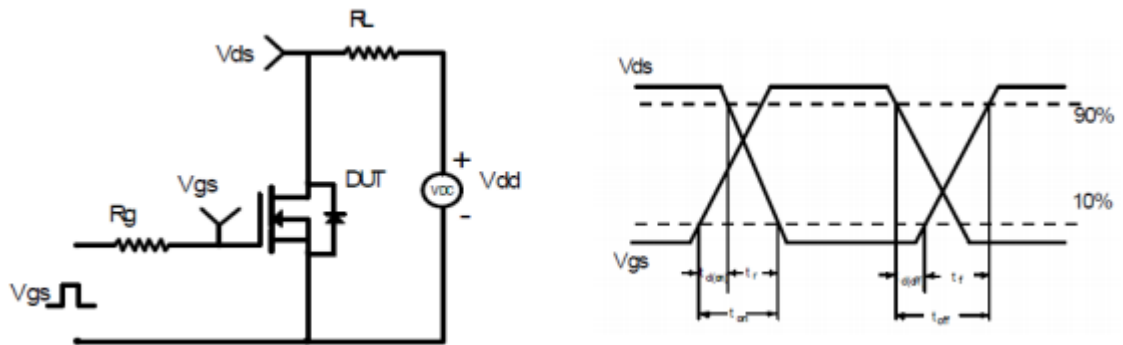

Figure B Switching Test Circuit & Waveforms

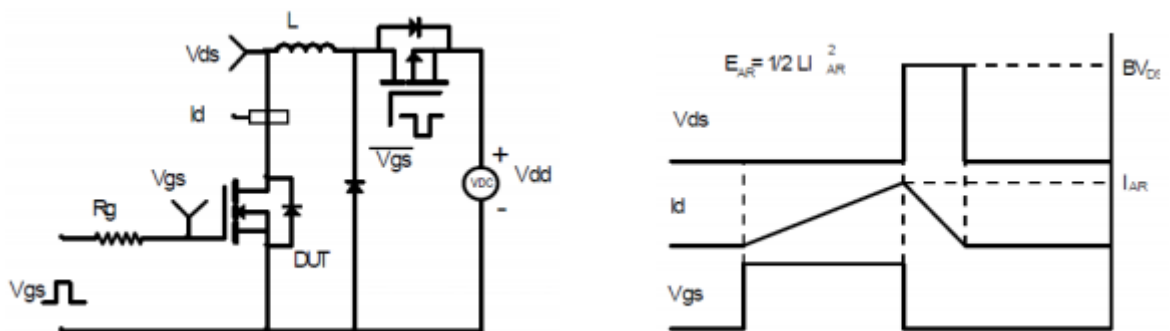
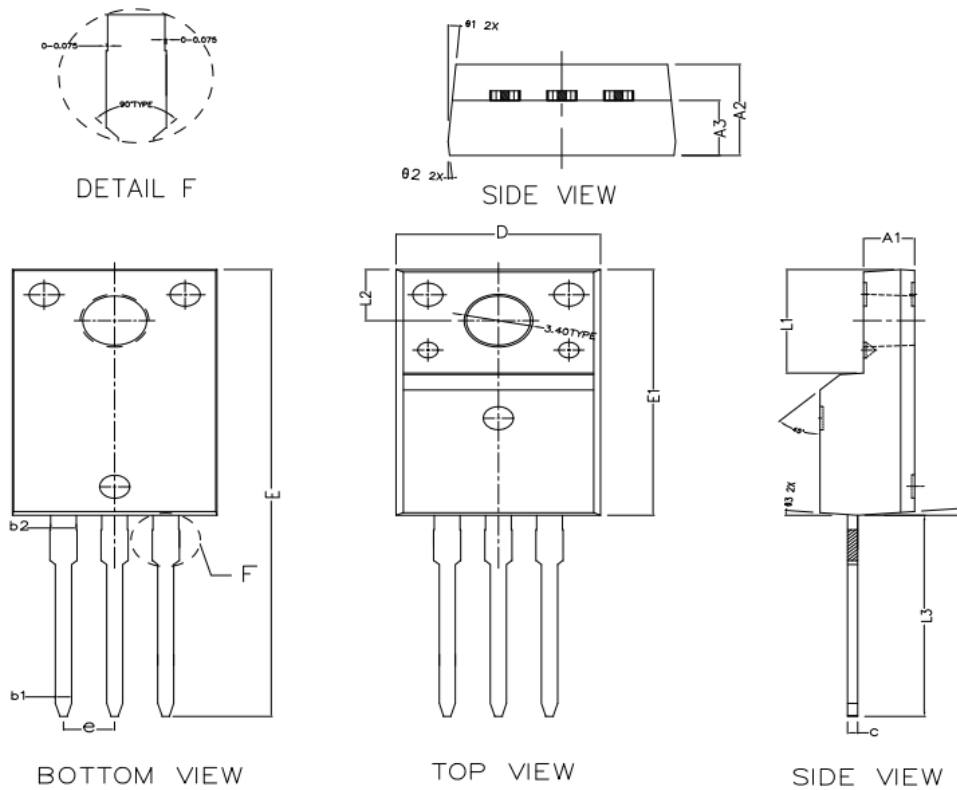

Figure C Unclamped Inductive Switching Circuit & Waveforms



TO-220F Package Outline Dimensions (Units: mm)



COMMON DIMENSIONS (UNITS OF MEASURE IS mm)			
	MIN	NORMAL	MAX
A1	2.440	2.540	2.640
A2	4.600	4.700	4.800
A3	2.730	2.830	2.930
b1	0.750	0.800	0.850
b2	1.230	1.280	1.330
c	0.450	0.500	0.550
D	10.060	10.160	10.260
E	28.650	28.850	29.050
E1	15.770	15.870	15.970
e	2.54TYPE		
L1	6.68REF		
L2	3.30REF		
L3	12.830	12.980	13.130
θ1	5° TYPE		
θ2	5° TYPE		
θ3	5° TYPE		
θ4	5° TYPE		