

**N And P- Channel Enhancement Mode Power MOSSFET****Features**

- Improved dv/dt Capability, High Ruggedness
- Maximum Junction Temperature Range (150°C)

Applications

- DC Fan
- Brushless motor
- Optimized for Power Management Applications for Portable Products, such as H-bridge, Inverters C ar Charger and Others

N-Channel		
BVDSS	30	V
ID	25	A
RDSON@VGS=10V	8.6	mΩ
RDSON@VGS=4.5V	15	mΩ

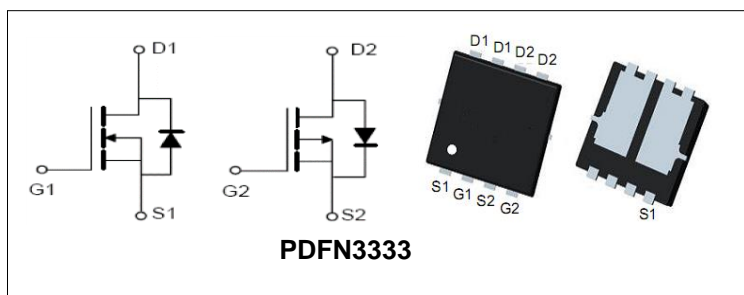

P-Channel		
BVDSS	-30	V
ID	-25	A
RDSON@VGS=-10V	17	mΩ
RDSON@VGS=-5V	24	mΩ

Order Information

Product	Package	Marking	Reel Size	Reel	Carton
PTQ25C03	PDFN3333	PTQ25C03	13inch	5000PCS	50000PCS

Absolute Maximum Ratings

Symbol	Parameter		N-Channel	P-Channel	Unit
Common Ratings (TC=25°C Unless Otherwise Noted)					
$V_{(BR)DSS}$	Drain-Source Breakdown Voltage		30	-30	V
V_{GS}	Gate-Source Voltage		±20	±20	V
T_J	Maximum Junction Temperature		150		°C
T_{STG}	Storage Temperature Range		-50 to 150		°C
I_S	Diode Continuous Forward Current	TC =25°C	25	-25	A
Mounted on Large Heat Sink					
I_{DM}	Pulse Drain Current Tested (Silicon Limit) (Note1)	TC =25°C	75	-75	A
I_D	Continuous Drain current	TC =25°C	25	-25	A
P_D	Maximum Power Dissipation	TC =25°C	20		W
$R_{θJC}$	Thermal Resistance Junction-to-Case (Note2)		6.25		°C/W



N And P- Channel Enhancement Mode Power MOSSFET

N-Channel Electrical Characteristics

Symbol	Parameter	Condition	Min.	Typ.	Max.	Unit
Static Electrical Characteristics @ T_J = 25°C (unless otherwise stated)						
V _{(BR)DSS}	Drain- Source Breakdown Voltage	VGS=0V ID=250μA	30	--	--	V
I _{DSS}	Zero Gate Voltage Drain current	VDS=30V,VGS=0V	--	--	1	μA
I _{GSS}	Gate-Body Leakage Current	VGS=±20V,VDS=0V	--	--	±100	nA
V _{GS(TH)}	Gate Threshold Voltage	VDS=VGS,ID=250μA	1	1.6	2.5	V
R _{DS(ON)}	Drain-Source On-State Resistance (Note3)	VGS=10V, ID=20A	--	8.6	13	mΩ
		VGS=4.5V, ID=10A	--	15	18	mΩ
Dynamic Electrical Characteristics @ T_J = 25°C (unless otherwise stated) (Note4)						
C _{iss}	Input Capacitance	VDS= 15V, VGS=0V, F=1MHz	--	970	--	pF
C _{oss}	Output Capacitance		--	197	--	pF
C _{rss}	Reverse Transfer Capacitance		--	113	--	pF
Q _g	Total Gate Charge	VDS= 15V, ID= 20A, VGS= 10V	--	12	--	nC
Q _{gs}	Gate-Source Charge		--	3	--	nC
Q _{gd}	Gate-Drain Charge		--	4	--	nC
Switching Characteristics (Note4)						
t _{d(on)}	Turn-on Delay Time	VDD=15V, ID=20A, VGS=10V, RG=1.8Ω	--	6	--	nS
t _r	Turn-on Rise Time		--	11	--	nS
t _{d(off)}	Turn-off Delay Time		--	12	--	nS
t _f	Turn-off Fall Time		--	5	--	nS
Source- Drain Diode Characteristics @ T_J = 25°C (unless otherwise stated)						
V _{SD}	Forward on voltage (Note3)	IS=20A,VGS=0V	--	0.82	1.2	V



N And P- Channel Enhancement Mode Power MOSSFET

P-Channel Electrical Characteristics

Symbol	Parameter	Condition	Min.	Typ.	Max.	Unit
Static Electrical Characteristics @ T_J = 25°C (unless otherwise stated)						
V _{(BR)DSS}	Drain- Source Breakdown Voltage	VGS=0V ID=-250μA	-30	--	--	V
I _{DSS}	Zero Gate Voltage Drain current	VDS=-30V,VGS=0V	--	--	1	μA
I _{GSS}	Gate-Body Leakage Current	VGS=±20V,VDS=0V	--	--	±100	nA
V _{GS(TH)}	Gate Threshold Voltage	VDS=VGS,ID=-250μA	-1.0	-2	-2.5	V
R _{DS(ON)}	Drain-Source On-State Resistance (Note3)	VGS=-10V, ID=-10.5A	--	17	22	mΩ
		VGS=-5V, ID=-6A	--	24	33	mΩ
Dynamic Electrical Characteristics @ T_J = 25°C (unless otherwise stated) (Note4)						
C _{iss}	Input Capacitance	VDS= -15V, VGS=0V, F=1MHz	--	3980	--	pF
C _{oss}	Output Capacitance		--	450	--	pF
C _{rss}	Reverse Transfer Capacitance		--	420	--	pF
Q _g	Total Gate Charge	VDS= -15V, ID= -15A,	--	81	--	nC
Q _{gs}	Gate-Source Charge		--	12	--	nC
Q _{gd}	Gate-Drain Charge	VGS= -10V	--	9.7	--	nC
Switching Characteristics (Note4)						
t _{d(on)}	Turn-on Delay Time	VDD=- 15V, ID=-15A, VGS=-10V, RG=3Ω	--	17	--	nS
t _r	Turn-on Rise Time		--	21	--	nS
t _{d(off)}	Turn-off Delay Time		--	36	--	nS
t _f	Turn-off Fall Time		--	15	--	nS
Source- Drain Diode Characteristics @ T_J = 25°C (unless otherwise stated)						
V _{SD}	Forward on voltage (Note3)	IS=-20A,VGS=0V	--	-0.8	-1.2	V

Note:

1. Repetitive Rating: Pulse width limited by maximum junction temperature.
2. Surface Mounted on FR4 Board, t ≤ 10 sec
3. Pulse Test: pulse width ≤ 300 us, duty cycle ≤ 2%.
4. Guaranteed by design, not subject to production testing.



N And P- Channel Enhancement Mode Power MOSSFET

Typical Characteristics (N-Channel)

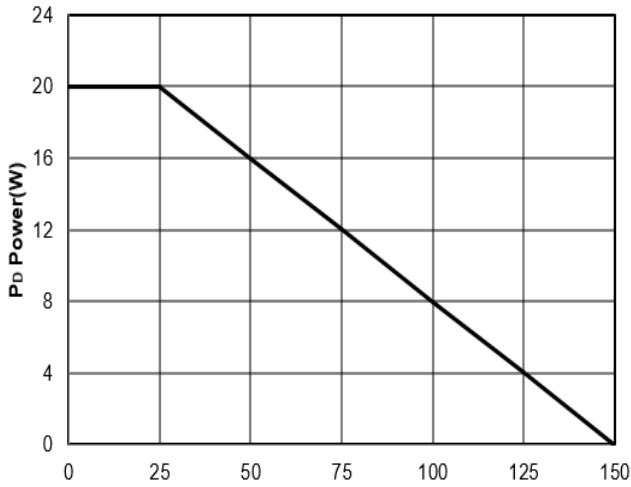

Figure1: T_J Junction Temperature (°C)

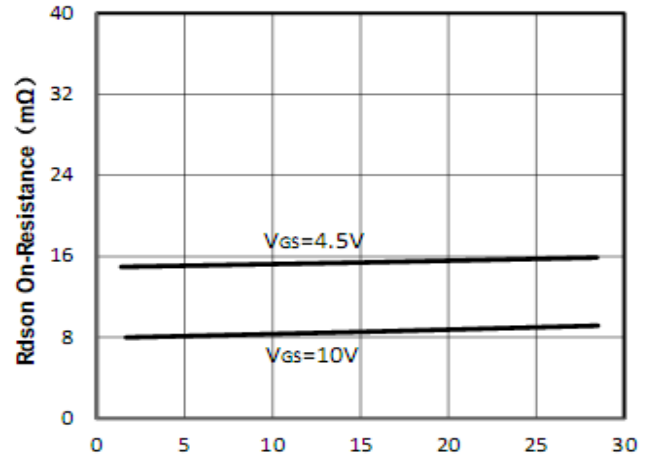

Figure2: I_D Drain Current (A)

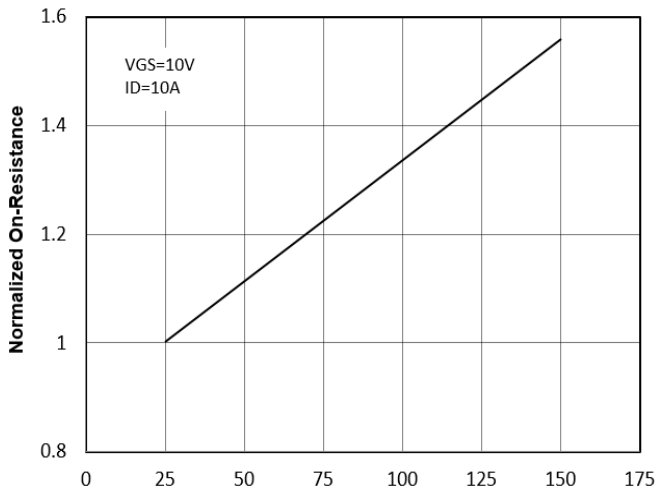

Figure3: T_J Junction Temperature (°C)

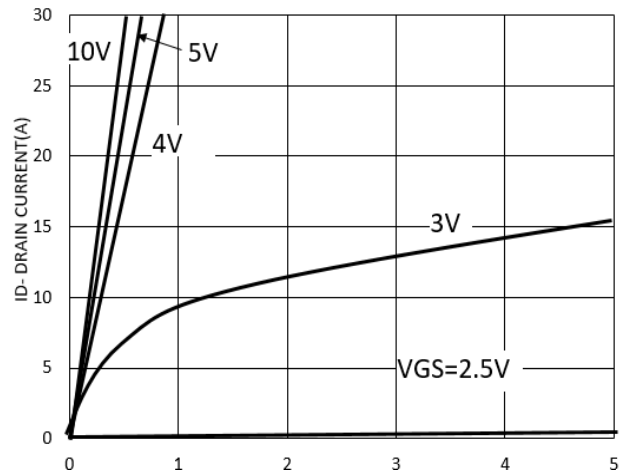

Figure4: V_{DS} Drain-Source Voltage (V)

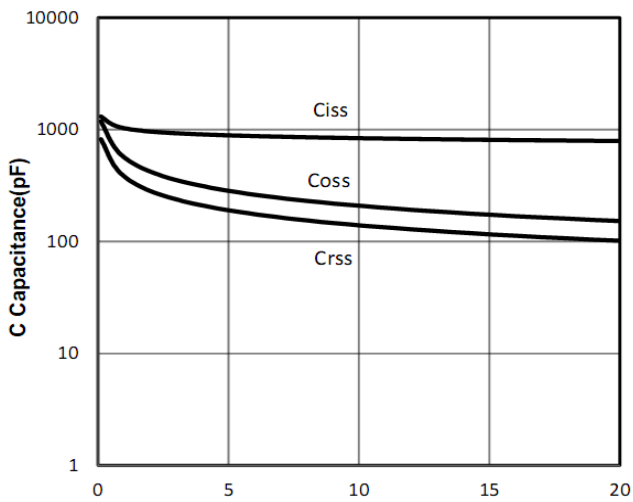

Figure5: V_{DS} Drain-Source Voltage (V)

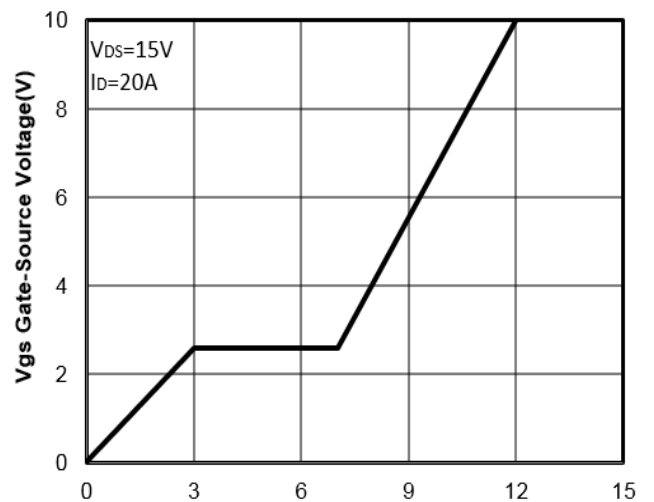

Figure6: Q_g Gate Charge (nC)



N And P- Channel Enhancement Mode Power MOSSFET

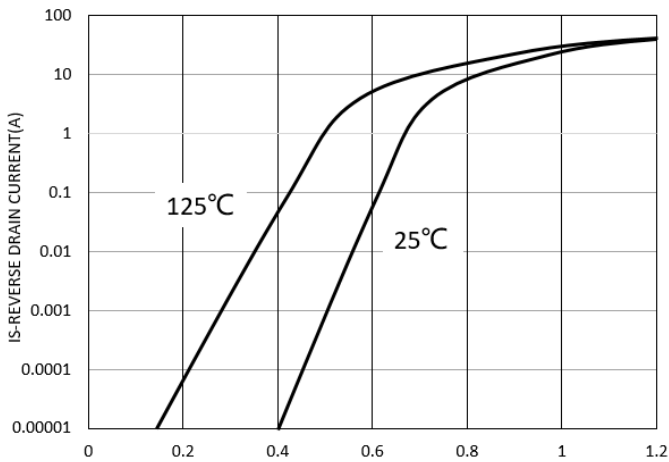

Figure7: Vsd Source-Drain Voltage (V)

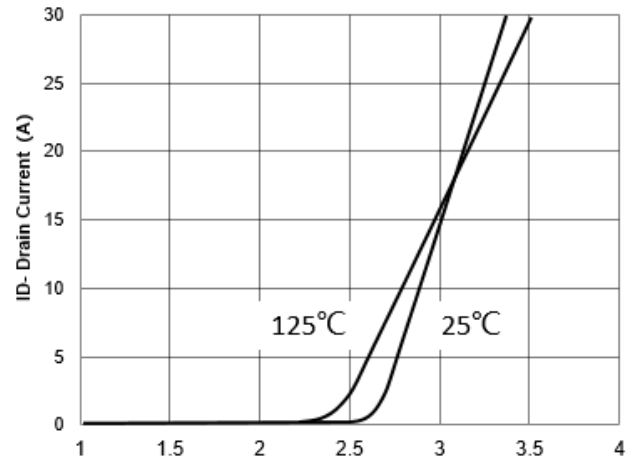

Figure8: Vgs Gate-Source Voltage (V)

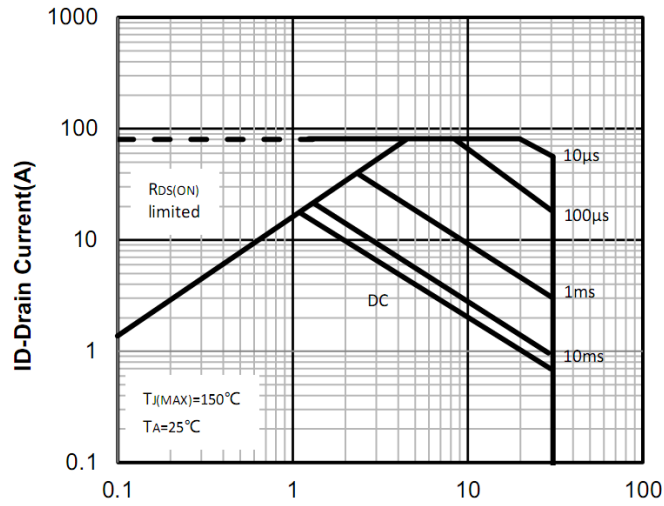

Figure9: VDS Drain -Source Voltage (V)

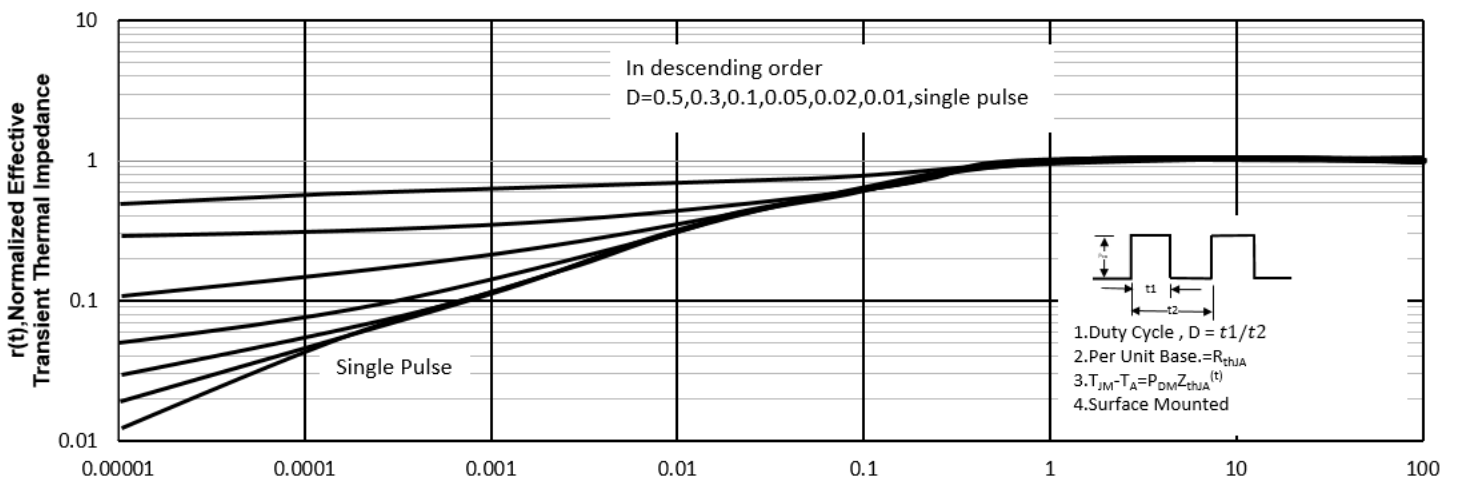

Figure10: Square Wave Pulse Duration (sec)

N And P- Channel Enhancement Mode Power MOSSFET

Test Circuit and Waveform(N-Channel):

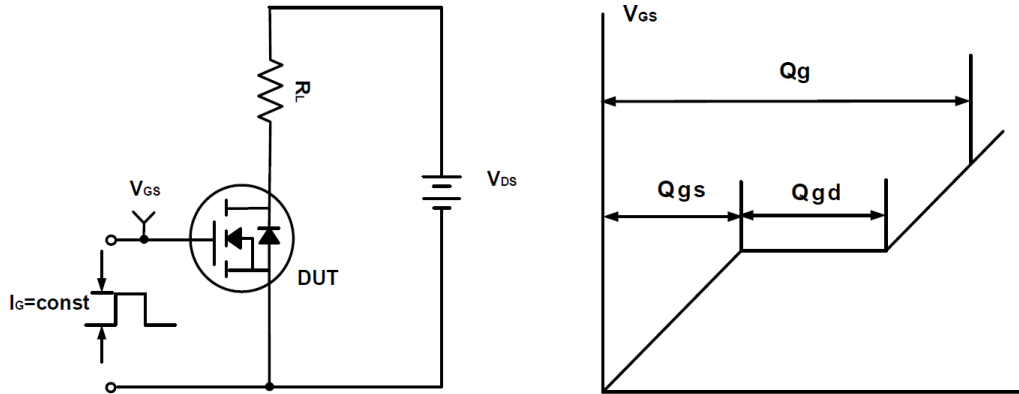

Figure A Gate Charge Test Circuit & Waveforms

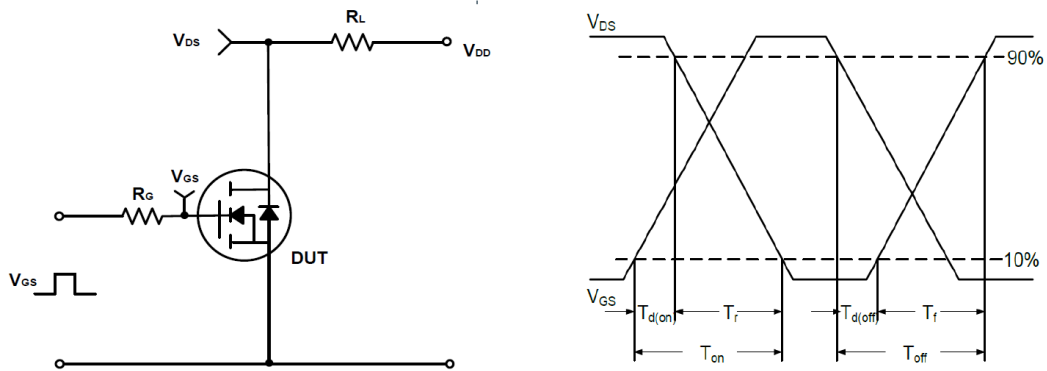

Figure B Switching Test Circuit & Waveforms

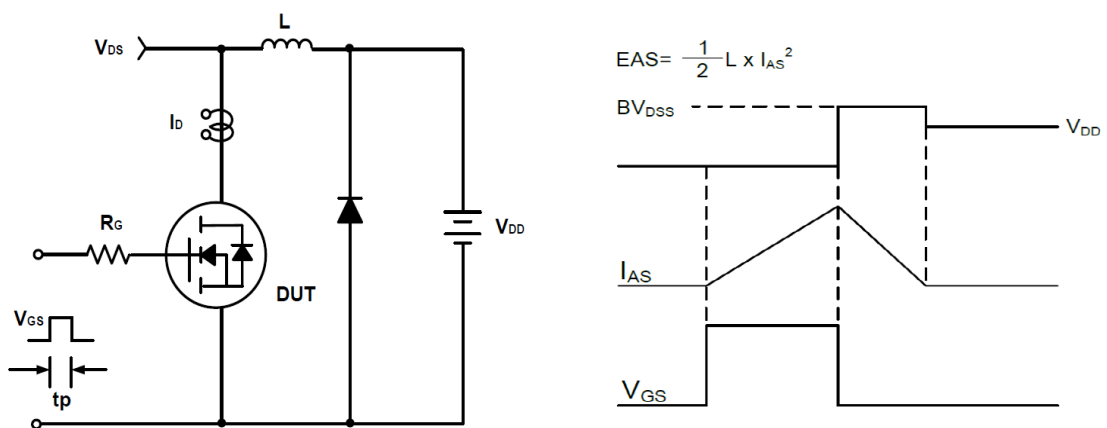

Figure C Unclamped Inductive Switching Circuit & Waveforms



N And P- Channel Enhancement Mode Power MOSSFET

Typical Characteristics (P-Channel)

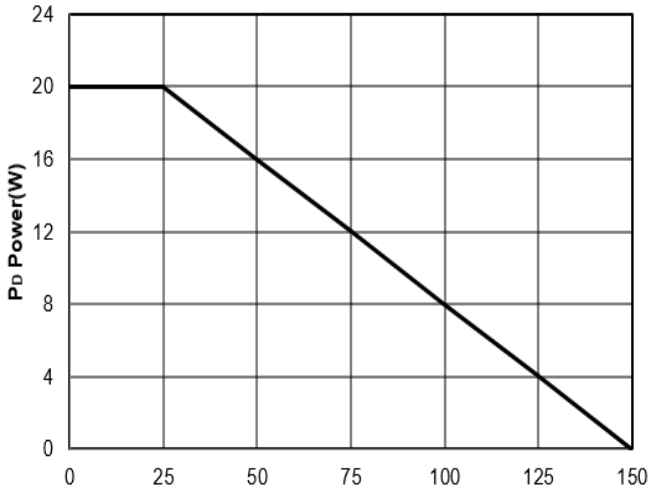

Figure11: Tj Junction Temperature (°C)

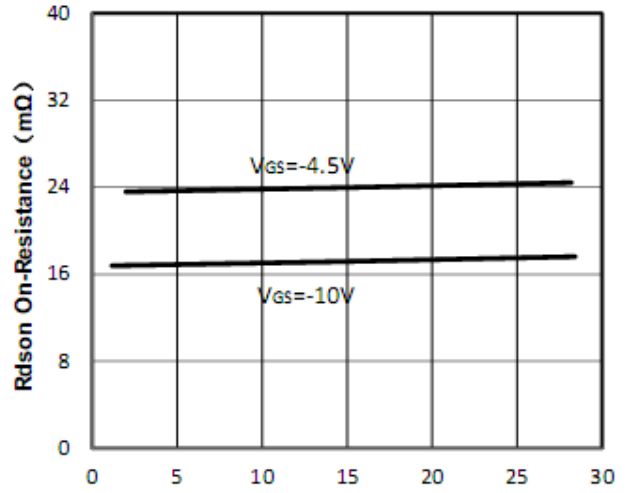

Figure12: -Id Drain Current (A)

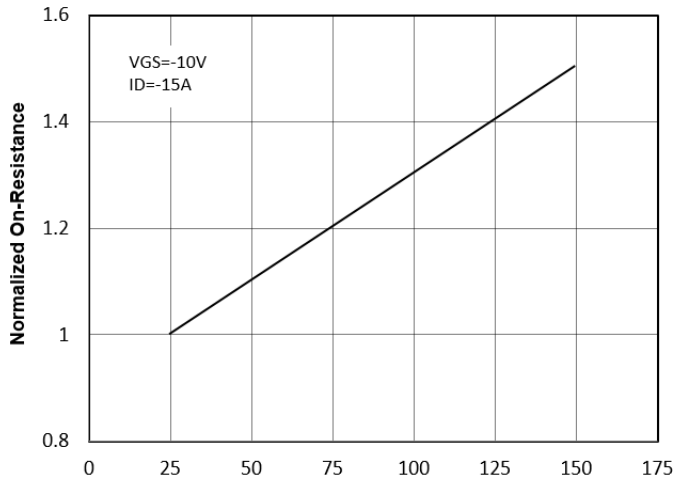

Figure13: Tj Junction Temperature (°C)

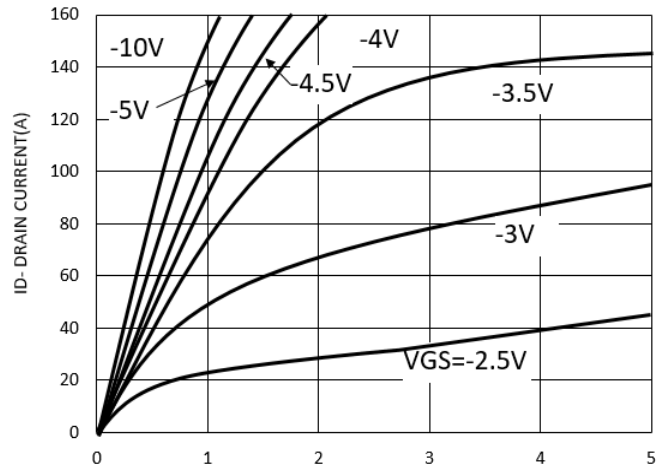

Figure14: -Vds Drain-Source Voltage (V)

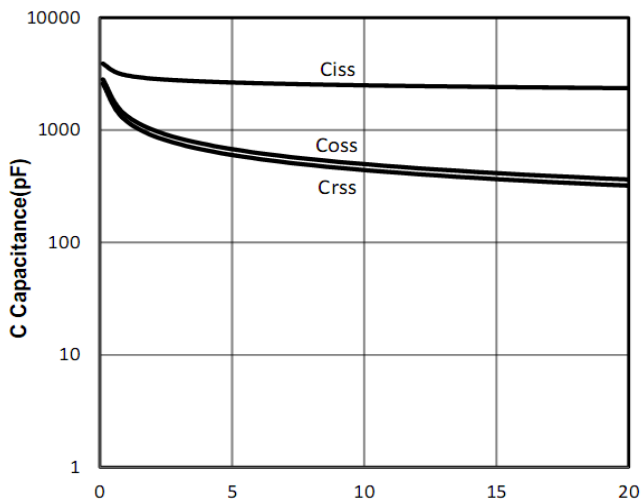

Figure15: -Vds Drain-Source Voltage (V)

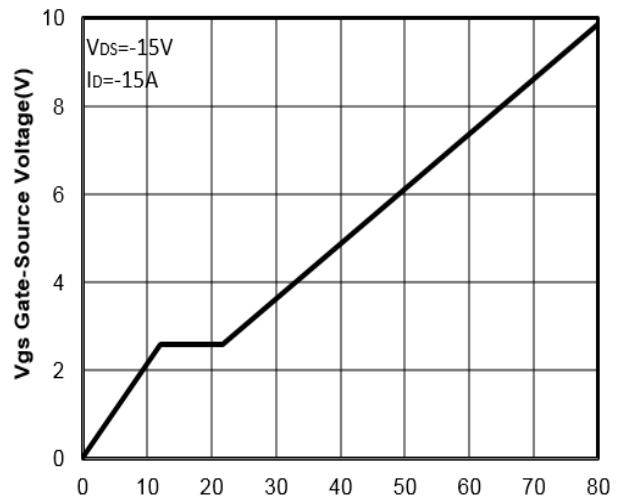

Figure16: Qg Gate Charge (nC)



N And P- Channel Enhancement Mode Power MOSSFET

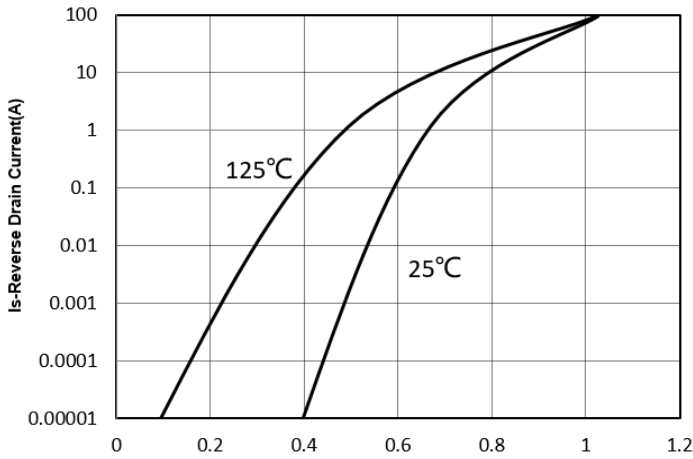

Figure17: -Vsd Source-Drain Voltage (V)

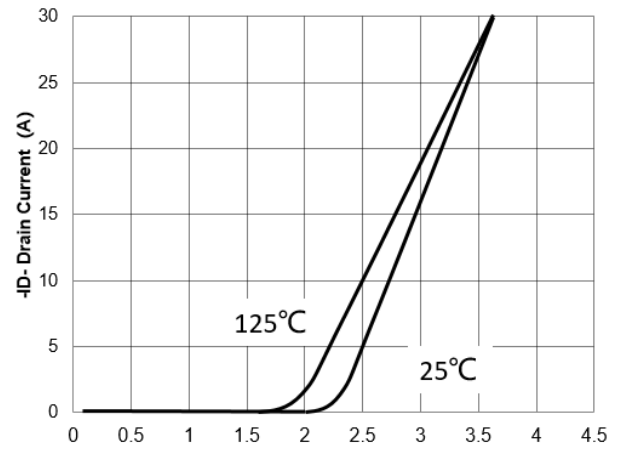

Figure18: -Vgs Gate-Source Voltage (V)

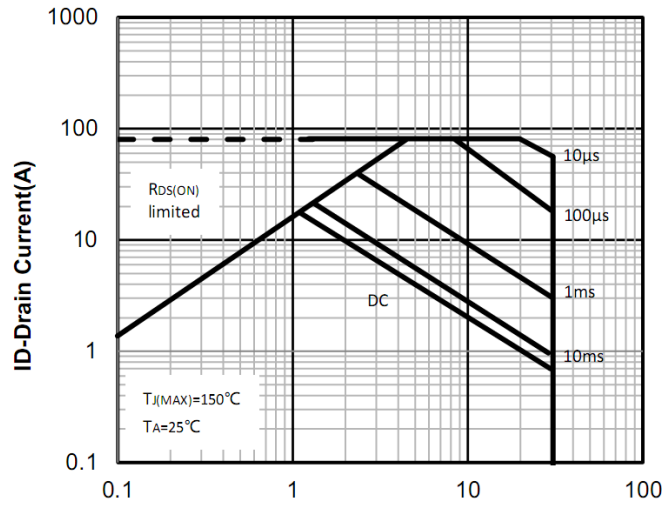

Figure19: -VDS Drain -Source Voltage (V)

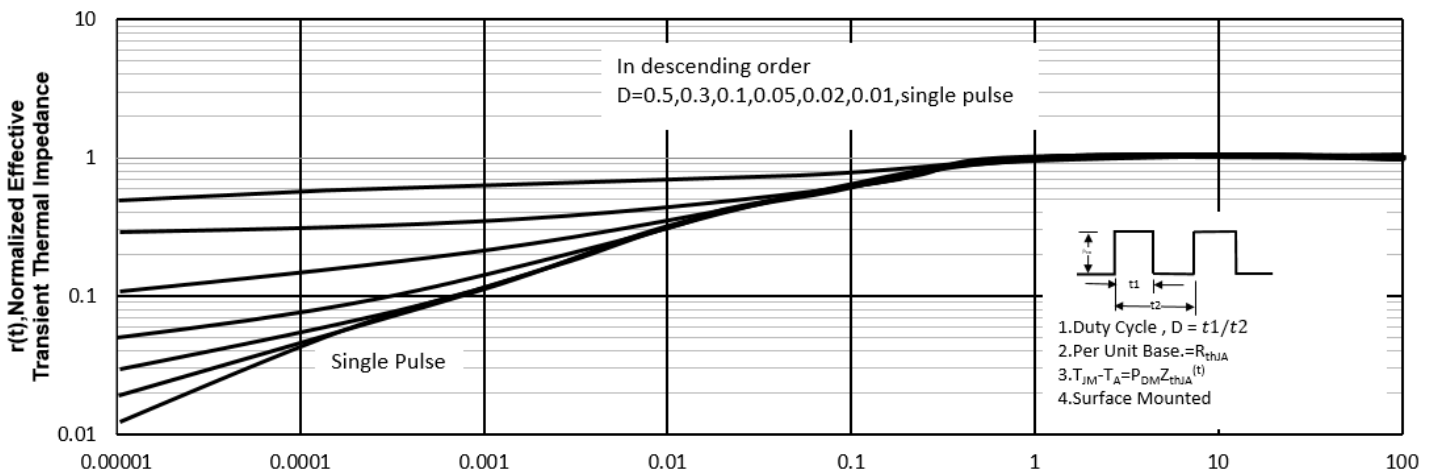

Figure20: Square Wave Pulse Duration (sec)

N And P- Channel Enhancement Mode Power MOSSFET

Test Circuit and Waveform (P-Channel):

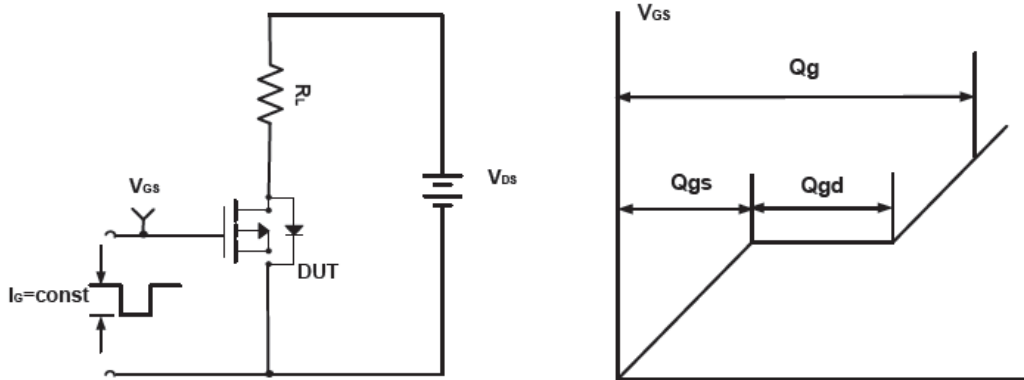

Figure D Gate Charge Test Circuit & Waveforms

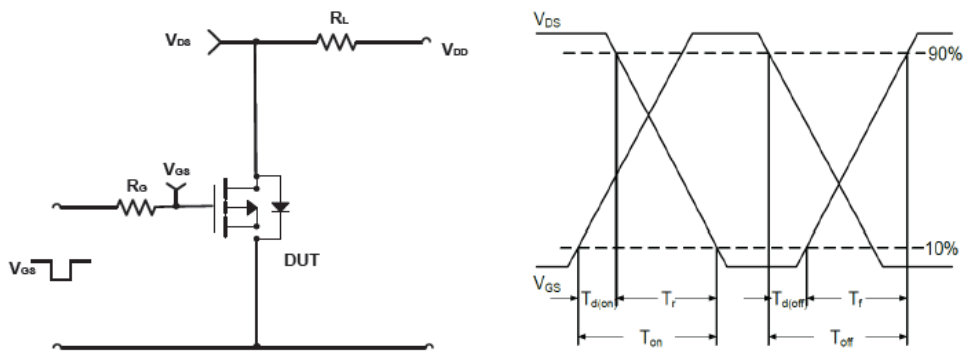

Figure E Switching Test Circuit & Waveforms

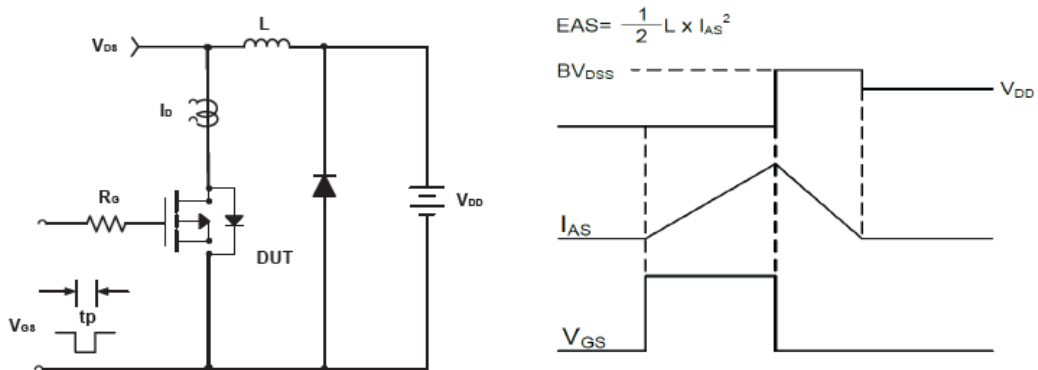
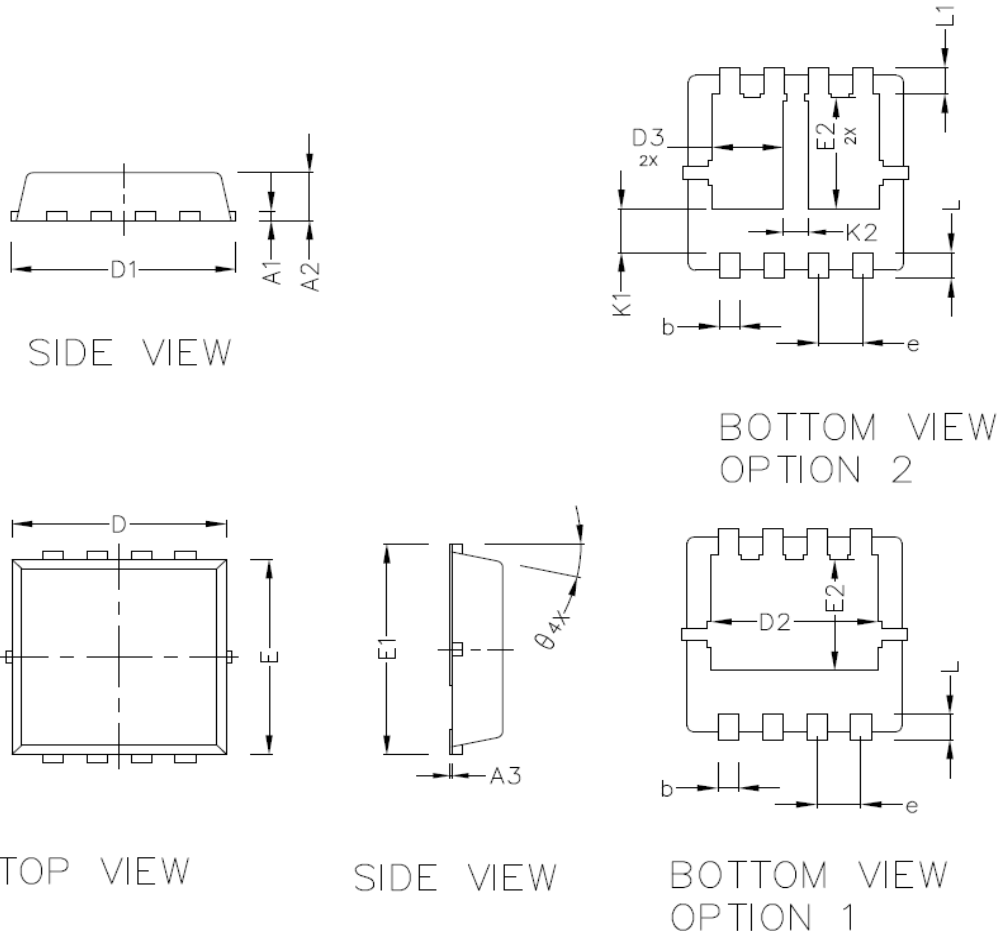

Figure F Unclamped Inductive Switching Circuit & Waveforms

N And P- Channel Enhancement Mode Power MOSSFET
PDFN3333 Package Outline Dimensions (Units: mm)

COMMON DIMENSIONS (UNITS OF MEASURE IS mm)			
	MIN	NORMAL	MAX
A1	0.152 BSC		
A2	0.650	0.750	0.850
A3	0.005	—	0.020
b	0.250	0.300	0.350
D	3.050	3.150	3.250
D1	3.200	3.300	3.400
D2	2.350	2.450	2.550
D3	0.935	1.035	1.135
E1	3.150	3.300	3.450
E	2.950	3.050	3.150
E2	1.635	1.735	1.835
e	0.650 TYPE		
L	0.300	0.400	0.500
θ	12° TYPE		
K1	0.680 REF		
K2	0.380 REF		
L1	0.410 REF		