

**20V N-Channel Enhancement Mode MOSFET****Features**

- Advanced trench process technology
- High Density Cell Design For Ultra Low On-Resistance
- High Power and Current handing capability

BVDSS	20	V
ID	4	A
RDSON@VGS=4.5V	27	mΩ
RDSON@VGS=2.5V	35	mΩ

Applications

- Low Side Load Switch
- Battery Switch
- Optimized for Power Management Applications for Portable Products, such as Aeromodelling, Power bank, Brushless motor, Main board , and Others

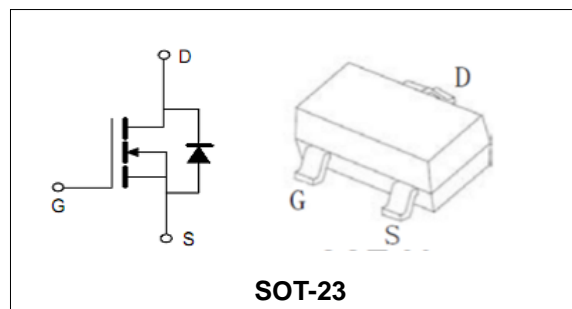
**Order Information**

Product	Package	Marking	Reel Size	Reel	Carton
PT2302D	SOT-23	A2sHB	7inch	3000PCS	180000PCS

Absolute Maximum Ratings

Symbol	Parameter	Rating	Unit
Common Ratings (TC=25°C Unless Otherwise Noted)			
$V_{(BR)DSS}$	Drain-Source Breakdown Voltage	20	V
V_{GS}	Gate-Source Voltage	±10	V
T_J	Maximum Junction Temperature	150	°C
T_{STG}	Storage Temperature Range	-55 to 150	°C
I_S	Diode Continuous Forward Current	$T_A = 25^\circ\text{C}$ 1.6	A
Mounted on Large Heat Sink			
I_{DM}	Pulse Drain Current Tested (Silicon Limit) (Note1)	$T_A = 25^\circ\text{C}$ 12	A
I_D	Continuous Drain current	$T_A = 25^\circ\text{C}$ 4	A
P_D	Maximum Power Dissipation	$T_A = 25^\circ\text{C}$ 1.25	W
$R_{\theta JA}$	Thermal Resistance Junction-to-Ambient (Note2)	100	°C/W



20V N-Channel Enhancement Mode MOSFET

Symbol	Parameter	Condition	Min.	Typ.	Max.	Unit
Static Electrical Characteristics @ T_J = 25°C (unless otherwise stated)						
V _{(BR)DSS}	Drain- Source Breakdown Voltage	VGS=0V ID=250μA	20	--	--	V
I _{DSS}	Zero Gate Voltage Drain current	VDS=16V,VGS=0V	--	--	1	μA
I _{GSS}	Gate-Body Leakage Current	VGS=±10V,VDS=0V	--	--	±100	nA
V _{GS(TH)}	Gate Threshold Voltage	VDS=VGS,ID=250μA	0.52	--	1.2	V
R _{DS(ON)}	Drain-Source On-State Resistance (Note3)	VGS=4.5V, ID=4A	--	27	40	mΩ
		VGS=2.5V, ID=3.5A	--	35	45	mΩ
Dynamic Electrical Characteristics @ T_J = 25°C (unless otherwise stated) (Note4)						
C _{iss}	Input Capacitance	VDS= 10V, VGS=0V, F=1MHz	--	340	--	pF
C _{oss}	Output Capacitance		--	115	--	pF
C _{rss}	Reverse Transfer Capacitance		--	33	--	pF
Q _g	Total Gate Charge	VDS= 10V, ID= 3A, VGS= 4.5V	--	5.4	--	nC
Q _{gs}	Gate-Source Charge		--	0.65	--	nC
Q _{gd}	Gate-Drain Charge		--	1.6	--	nC
Switching Characteristics (Note4)						
t _{d(on)}	Turn-on Delay Time	VDD=10V, RL=5.5Ω, RG=6Ω, VGS=4.5V	--	12	--	nS
t _r	Turn-on Rise Time		--	36	--	nS
t _{d(off)}	Turn-off Delay Time		--	34	--	nS
t _f	Turn-off Fall Time		--	10	--	nS
Source- Drain Diode Characteristics @ T_J = 25°C (unless otherwise stated)						
V _{SD}	Forward on voltage (Note3)	IS=1A,VGS=0V	--	--	1.2	V

Note:

1. Repetitive Rating: Pulse width limited by maximum junction temperature.
2. Surface Mounted on FR4 Board, t ≤ 10 sec
3. Pulse Test: pulse width ≤ 300 us, duty cycle ≤ 2%.
4. Guaranteed by design, not subject to production testing.



20V N-Channel Enhancement Mode MOSFET

Typical Characteristics

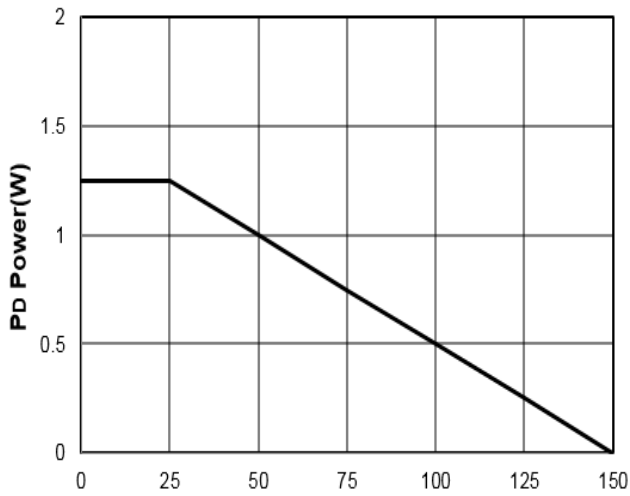

Figure1: T_j Junction Temperature (°C)

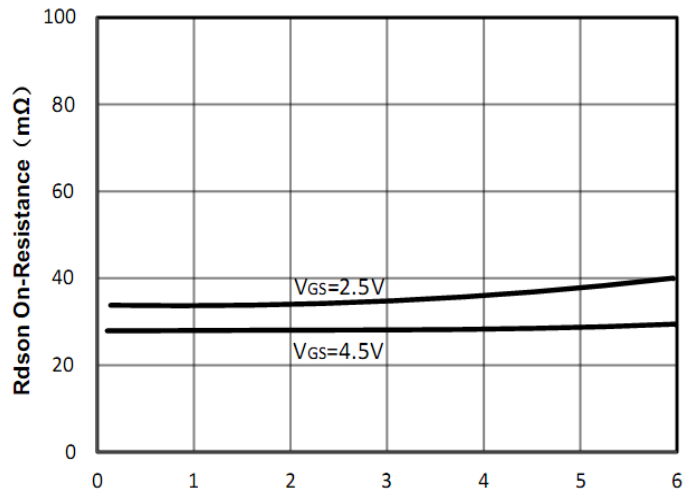

Figure2: I_d Drain Current (A)

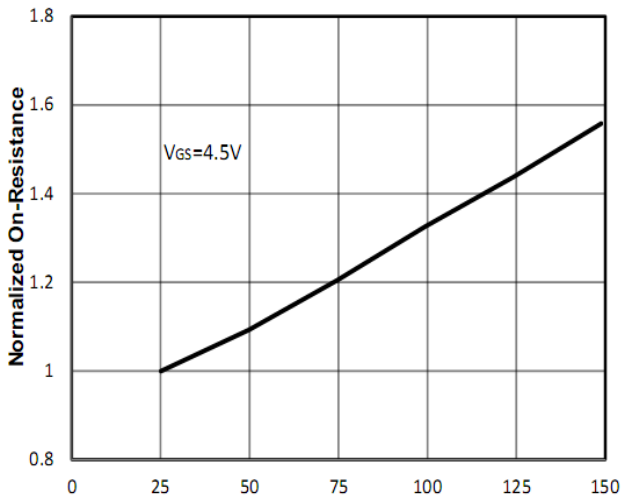

Figure3: T_j Junction Temperature (°C)

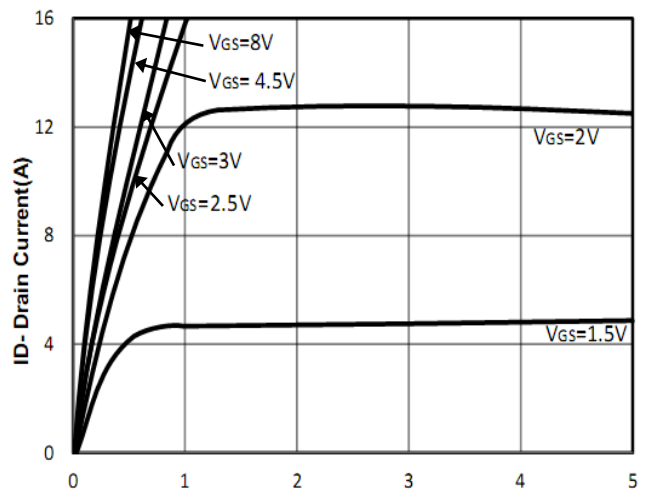

Figure4: V_{ds} Drain-Source Voltage (V)

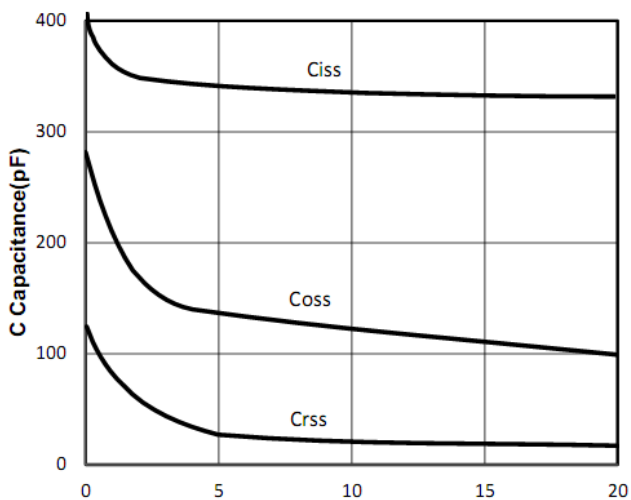

Figure5: V_{ds} Draun-Source Voltage (V)

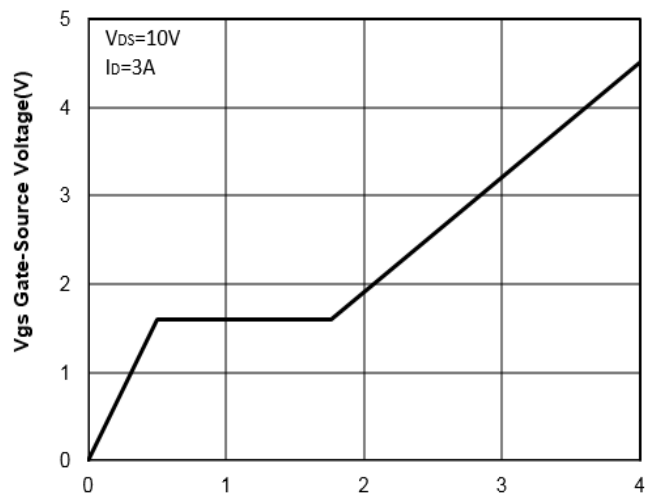

Figure6: Q_g Gate Charge (nC)



20V N-Channel Enhancement Mode MOSFET

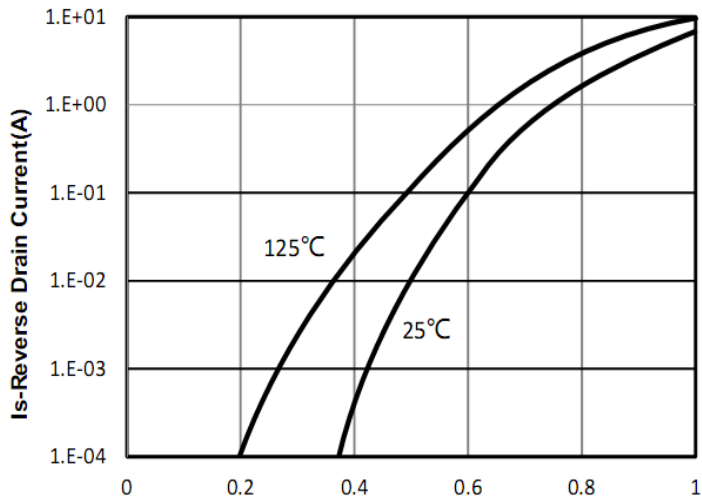

Figure7: Vsd Source-Drain Voltage (V)

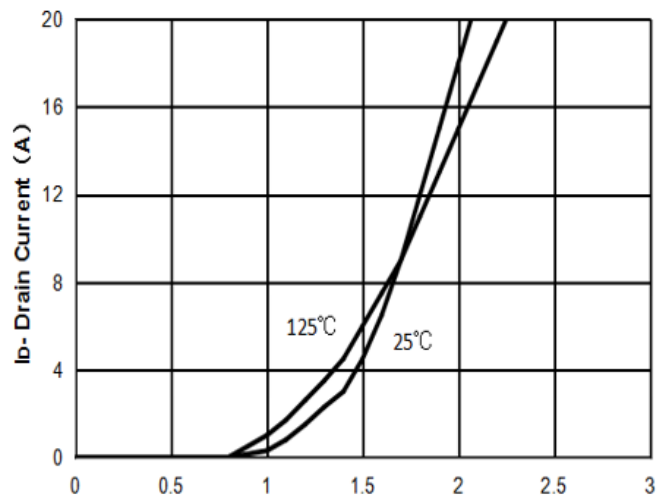

Figure8: Vgs Gate-Source Voltage (V)

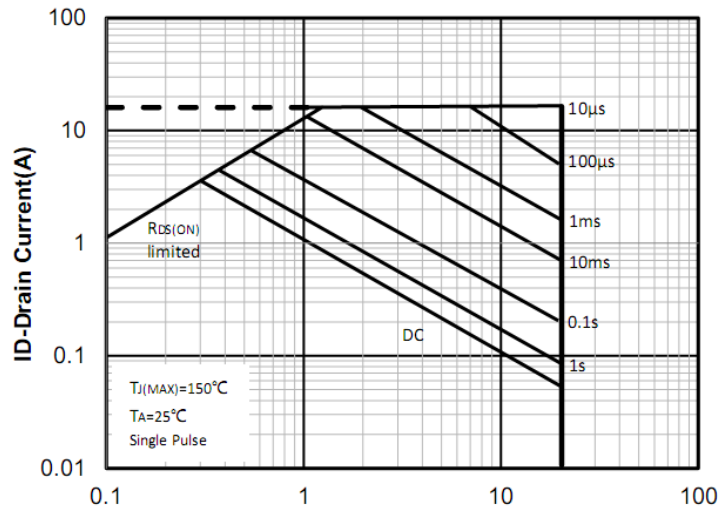

Figure9: Vds Drain -Source Voltage (V)

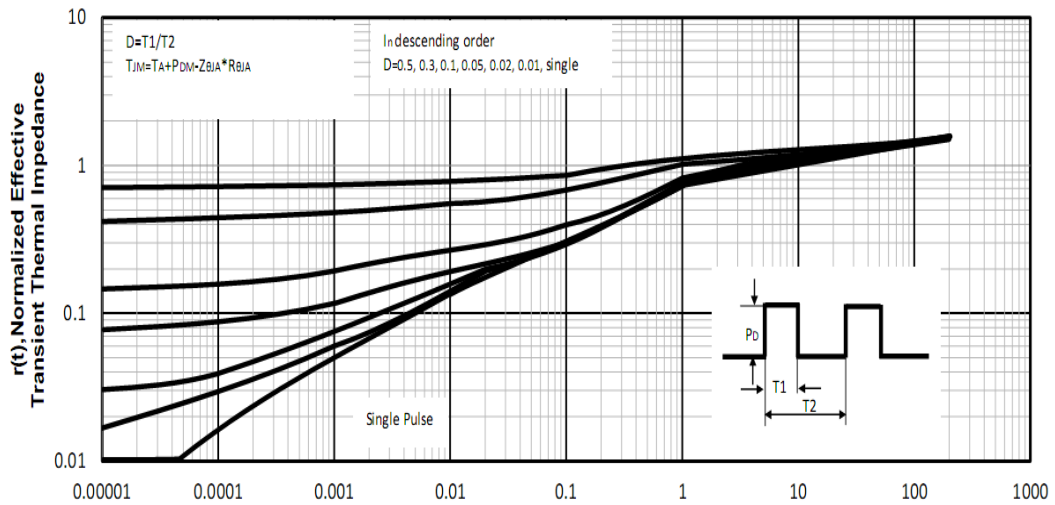
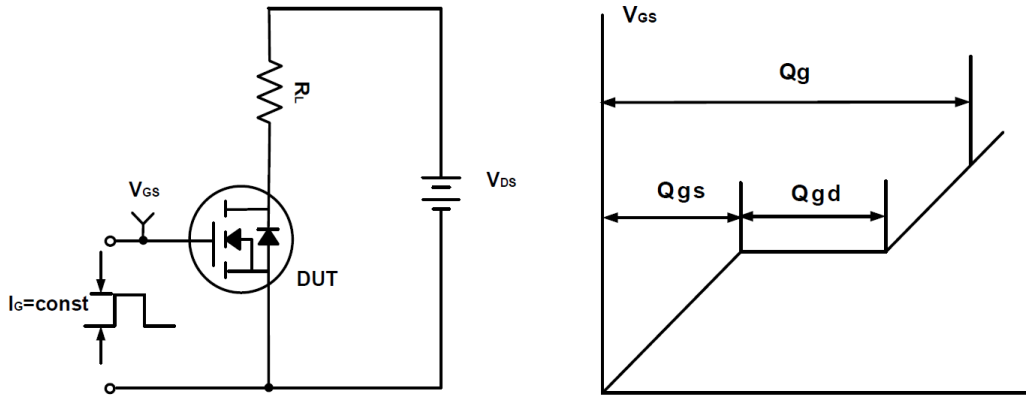
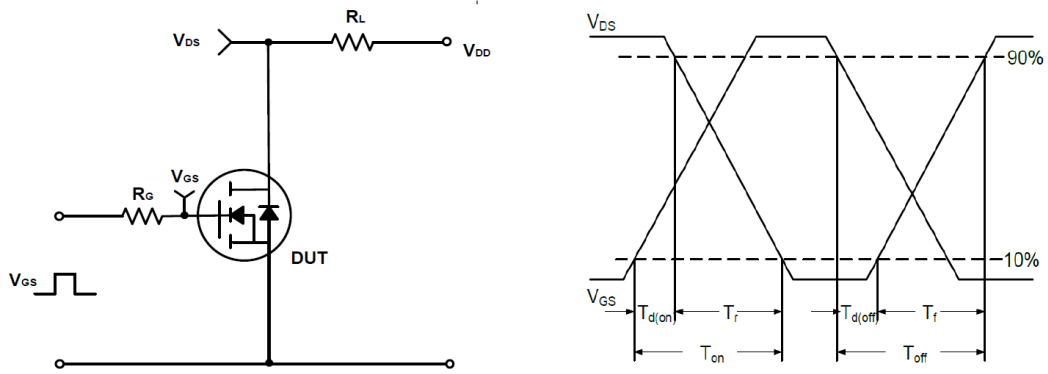
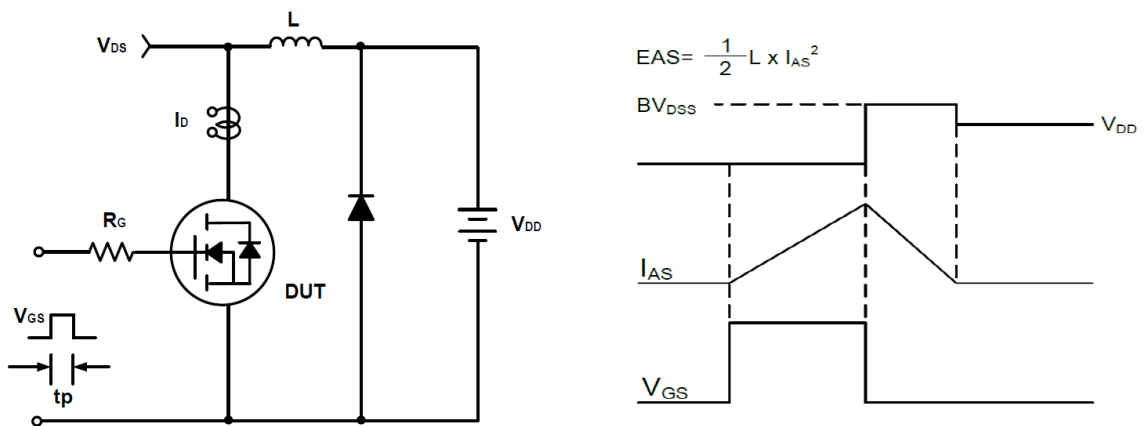

Figure10: Square Wave Pulse Duration (sec)

20V N-Channel Enhancement Mode MOSFET
Test Circuit and Waveform:

Figure A Gate Charge Test Circuit & Waveforms

Figure B Switching Test Circuit & Waveforms

Figure C Unclamped Inductive Switching Circuit & Waveforms

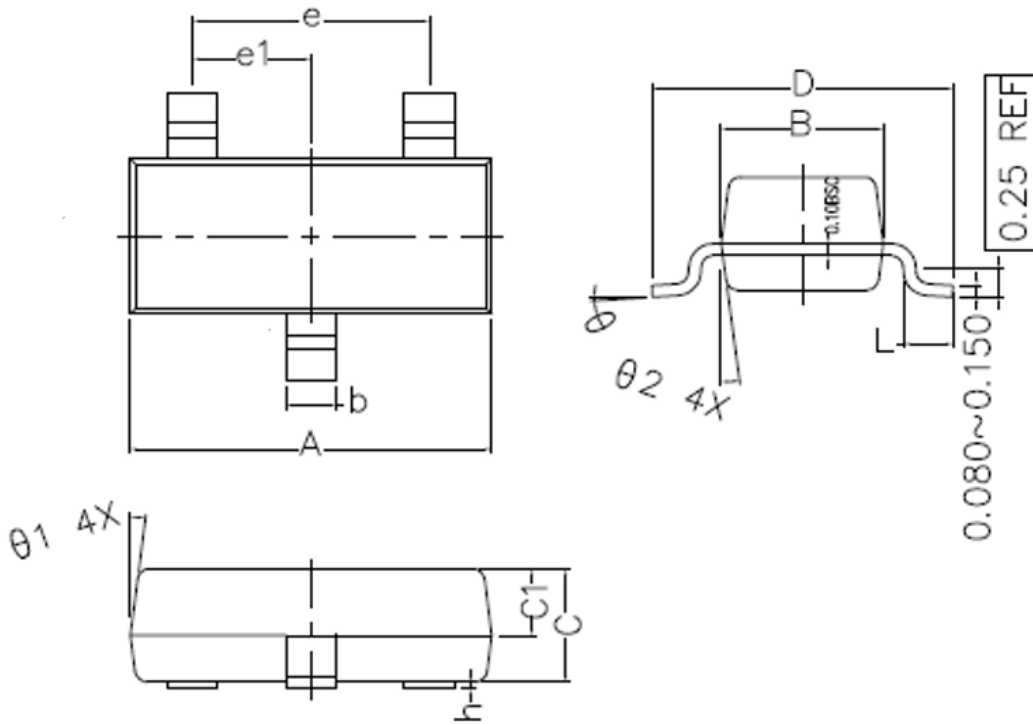

20V N-Channel Enhancement Mode MOSFET

SOT-23 Package Outline Dimensions (Units: mm)



COMMON DIMENSIONS (UNITS OF MEASURE IS mm)			
	MIN	NORMAL	MAX
A	2.800	2.900	3.000
B	1.200	1.300	1.400
C	0.900	1.000	1.100
C1	0.500	0.550	0.600
D	2.250	2.400	2.550
L	0.300	0.400	0.500
h	0.010	0.050	0.100
b	0.300	0.400	0.500
e	1.90 TYPE		
e1	0.95 TYPE		
θ_1	7° TYPE		
θ_2	7° TYPE		
θ	0° ~ 7°		